



Product Catalogue 2026



ABOUT BALAJI SWITCHGEARS

Balaji Switchgears, established in 1990, is one of India's leading technology partners for Industrial Electrical, Automation, and Power Distribution Solutions.

With nearly 4 decades of industry expertise, we serve OEMs, Panel Builders, System Integrators, Contractors, and Industrial End Users across diverse sectors including Food & Beverage, Packaging, Oil & Gas, Chemicals, Defence, Infrastructure, and Government Projects.

Our comprehensive portfolio includes Low Voltage Switchgears, Industrial Automation, Sensing Solutions, Power Management Systems, Enclosures, Connectivity Products, Cables, Panel Components, and Customized Engineering Solutions from globally trusted principal partners.

Backed by a dedicated team, we provide value-added services including panel commissioning, programming support, technical consultation, and after-sales assistance. With fast response times, nationwide reach, and a commitment to quality, reliability, and customer satisfaction, Balaji Switchgears continues to empower industries with complete end-to-end automation and electrical solutions.

This portfolio presents our key product categories and solutions designed to support modern industrial operations with efficiency, safety, and performance.

OUR PRINCIPLE PARTNER

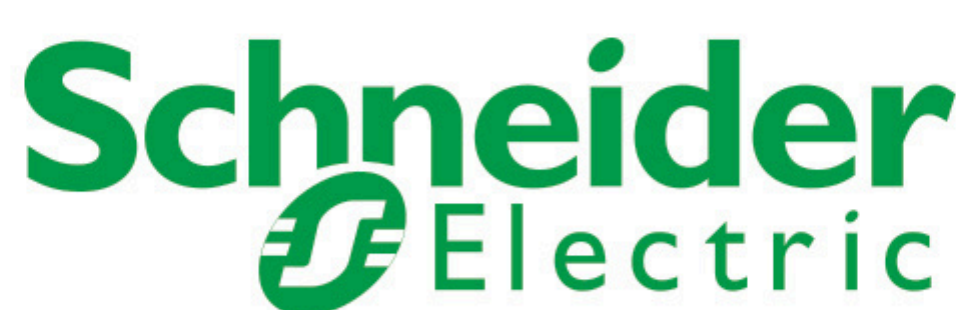

LOW-VOLTAGE SWITCHGEARS

We offers a comprehensive range of **Schneider Electric** Low Voltage Switchgear solutions designed for safe, reliable and efficient power distribution across industrial and commercial applications. From circuit protection to motor control, these solutions ensure operational safety, system reliability and long-term performance.



Air Circuit Breakers (ACB)



Miniature Circuit Breakers (MCB)



Motor Protection Circuit Breaker (MPCB)



Moulded Case Circuit Breakers (MCCB)



Plugs & Sockets (Pratika)



Power Factor & Correction Products



Surge Protection Devices



Contactors & Overload Relays



Distribution Boards



Energy Meters

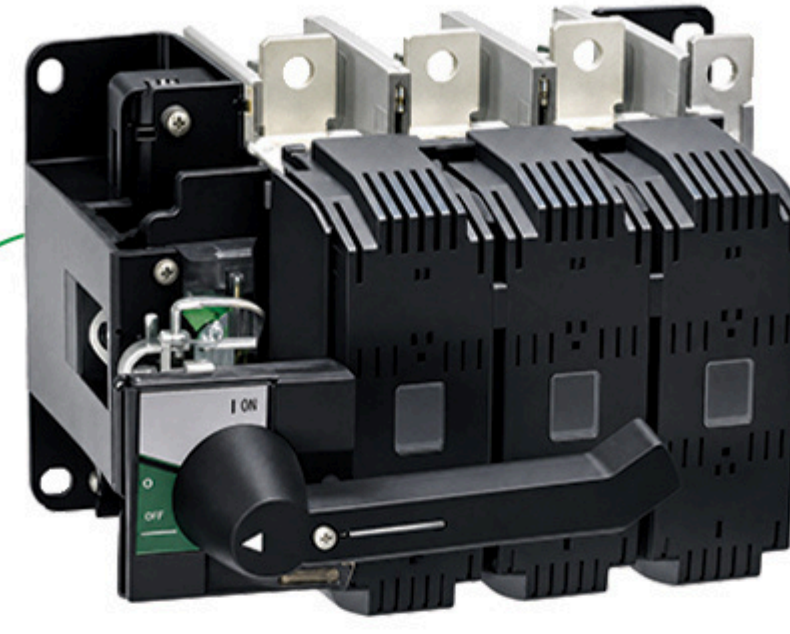

Switch Disconnecter Fuse

INDUSTRIAL AUTOMATION

Schneider Electric Industrial Automation solutions help industries improve productivity, operational efficiency and process reliability through advanced control and monitoring technologies. From machine automation to process control, these solutions are built to support smarter and more connected industrial operations.

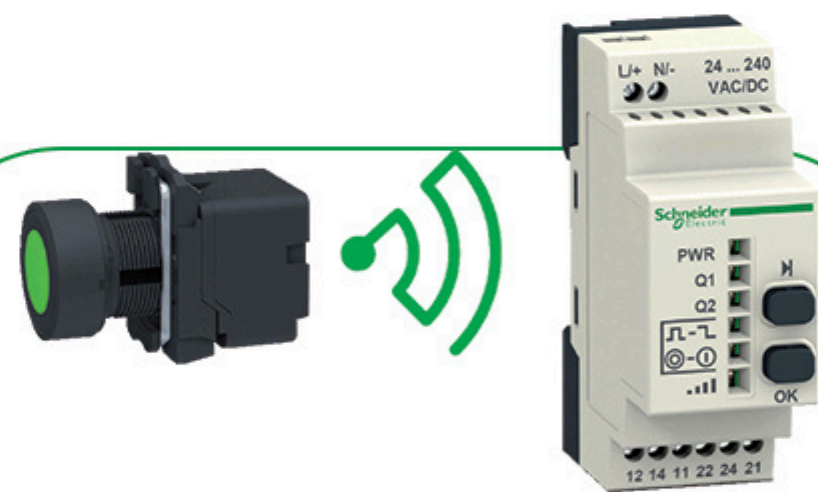

Control & Signalling
(Pushbuttons & Indicators)



Human Machine
Interface (HMI)



Programmable Logic
Controller (PLC)



Miniature Relays



Servo Motor & Drives



SMPS



Soft Starters



Variable Frequency Drive (VFD)

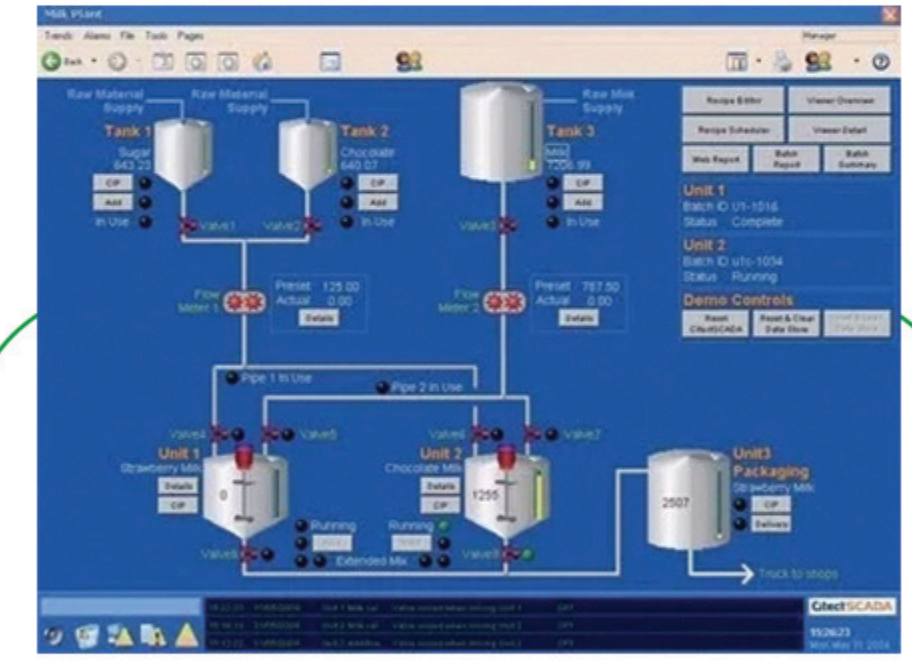

SCADA System



Control Relay

INDUSTRIAL AUTOMATION

We offers a wide range of **Omron** Industrial Automation solutions designed to enhance machine performance, improve productivity and enable smarter industrial operations. From sensing and control to motion and safety, Omron technologies help industries achieve greater precision, reliability and operational efficiency.



Counter



Timer

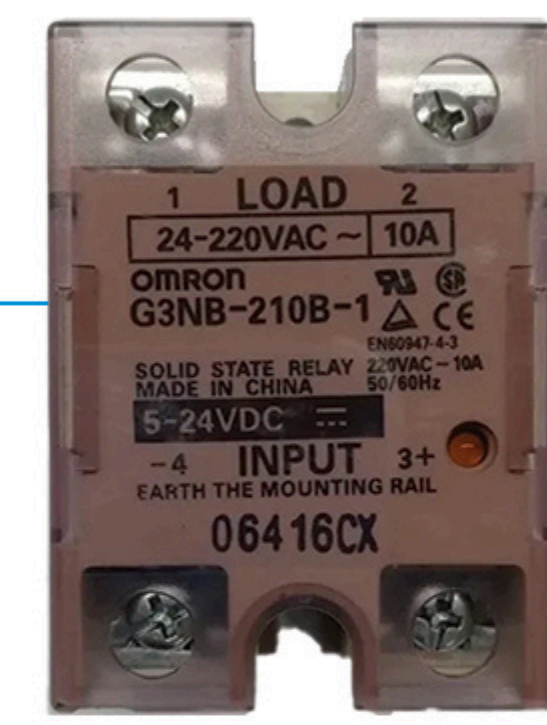

Solid State Relay (SSR)



Relay



Sensors



Safety Light Curtain

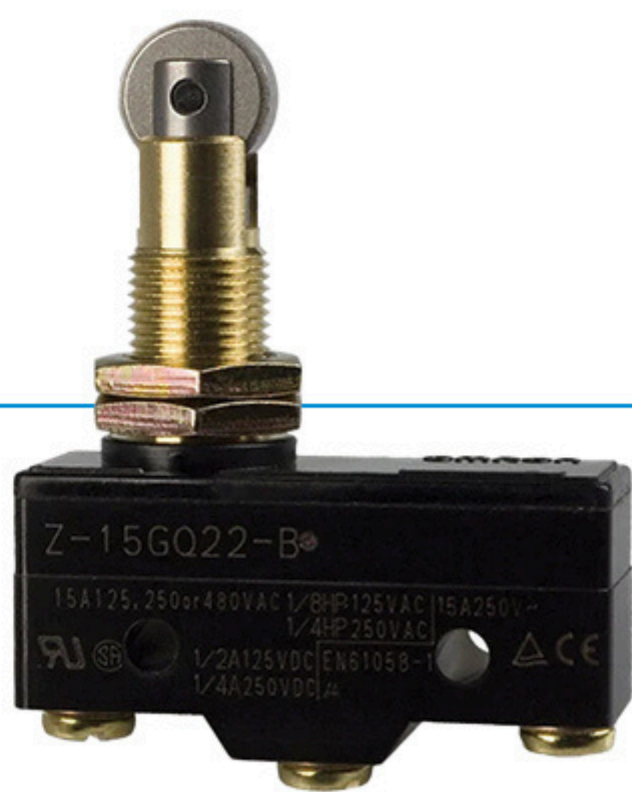

Micro Limit Switch



Limit Switch



Power Supply (SMPS)



Programmable Logic Controller (PLC)



Human Machine Interface (HMI)



Safety Door Switch



Safety Relay

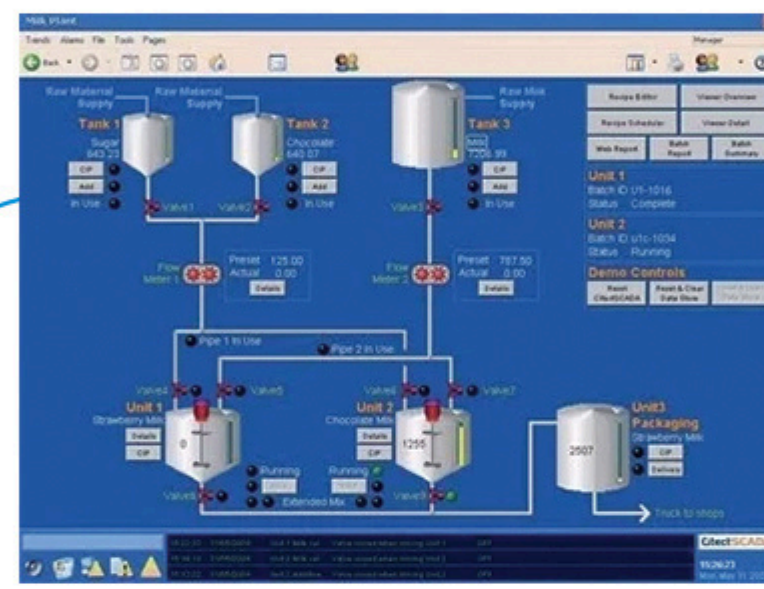

SCADA



Temperature Controllers (PID)



Encoder



Modular Power Supply

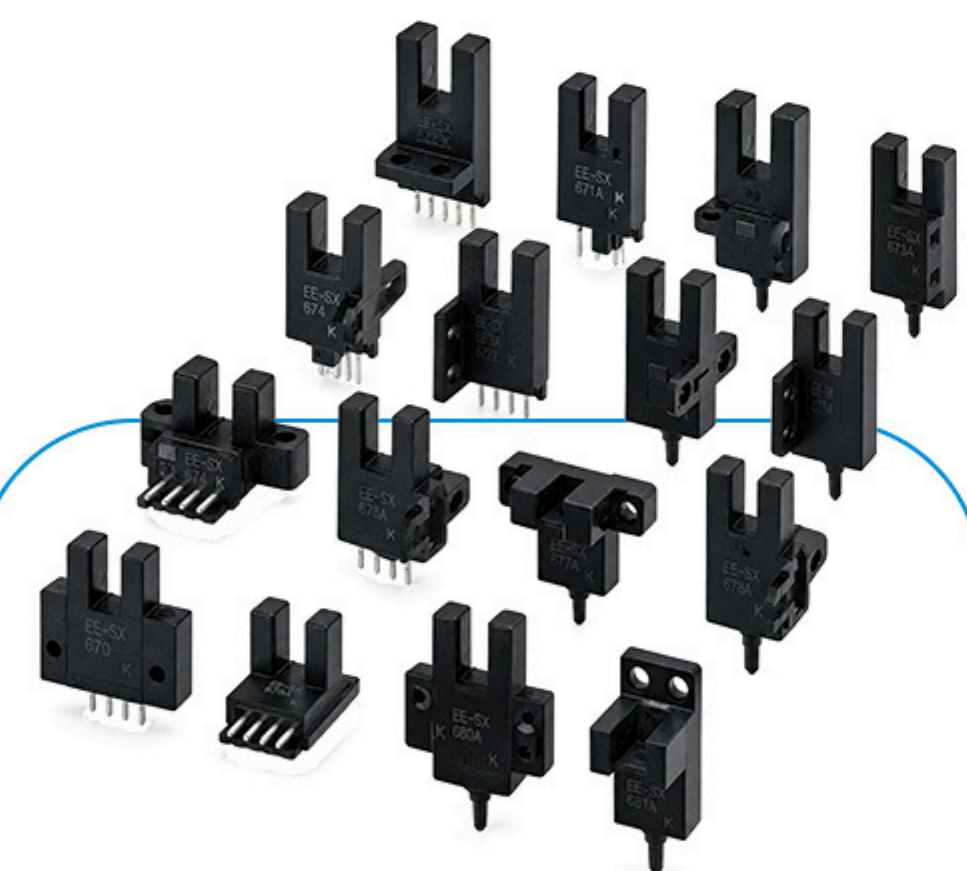

Photomicro Sensor

INDUSTRIAL CONNECTIVITY & CABLE SOLUTIONS

We offer a comprehensive range of **LAPP** connectivity solutions engineered for reliable power, signal and data transmission across industrial environments. Designed for demanding applications, LAPP products deliver durability, flexibility and consistent performance for automation systems, machinery and panel installations.



Power & Control Cable



Data Communication System



Data Communication System For Ethernet Technology

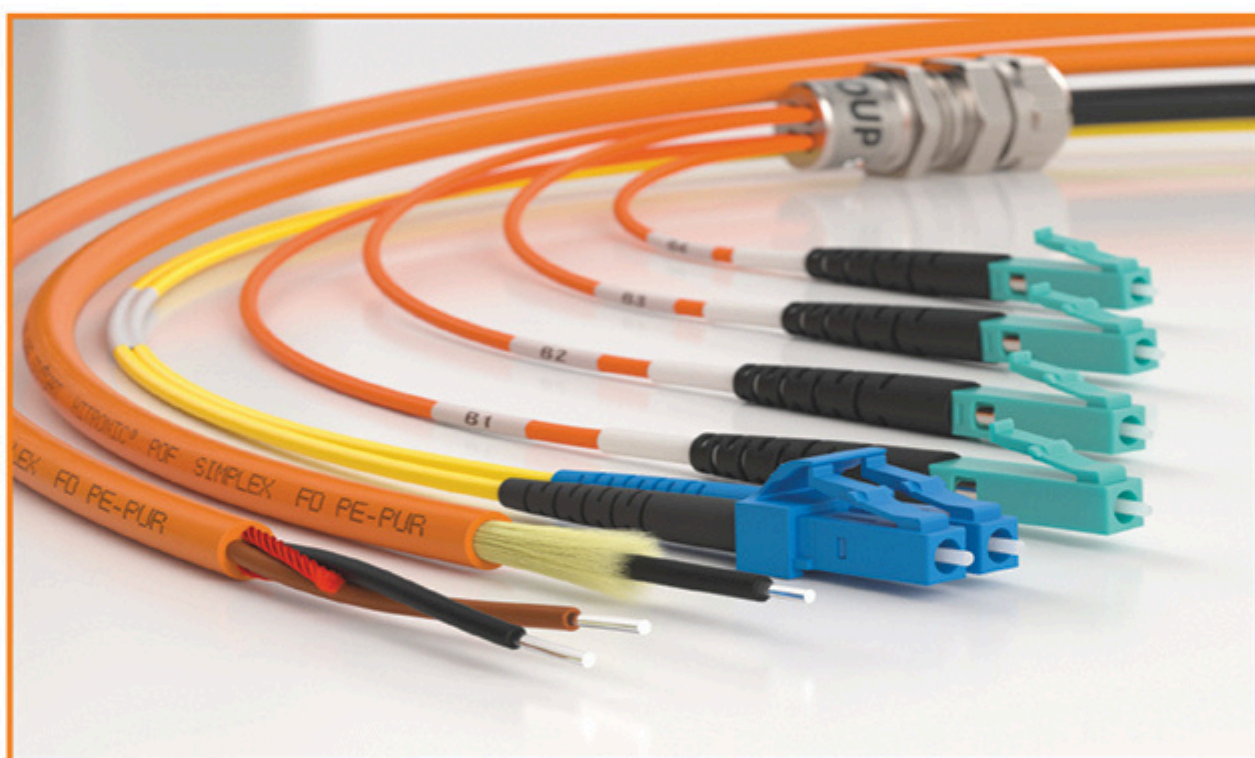

Optical Transmission System



Industrial Connectors



Cable Glands



Protective Cable Conduit System & Cable Carrier System



Marking System

LOW-VOLTAGE SWITCHGEARS

We offer a comprehensive range of **ABB** Low Voltage Switchgear solutions for efficient power distribution across industrial and commercial applications. From circuit protection and motor control to power management, ABB solutions help enhance operational safety, improve system reliability and support long-term electrical performance.



Air Circuit Breakers (ACB)



Miniature Circuit Breakers (MCB)

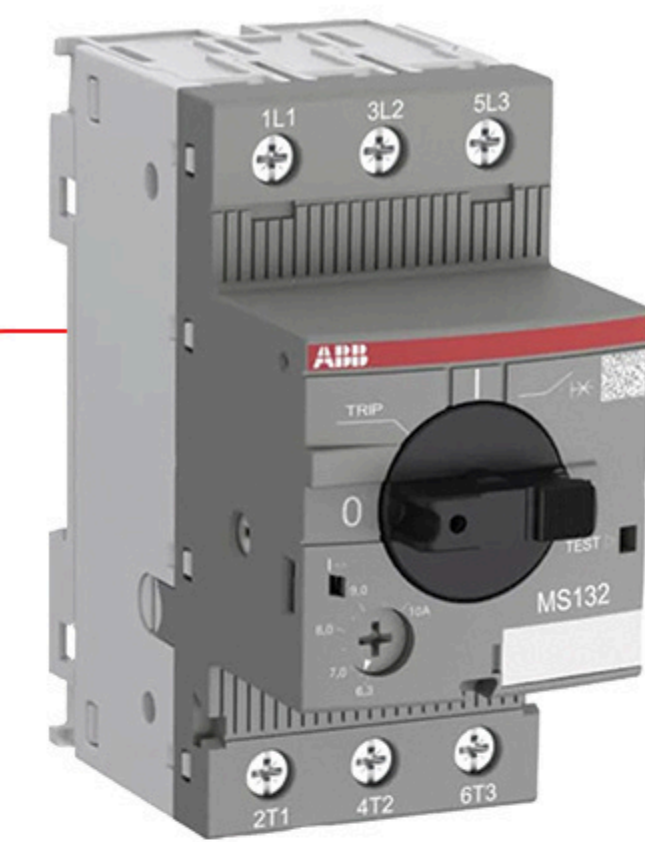

Motor Protection Circuit Breaker (MPCB)



Moulded Case Circuit Breakers (MCCB)



Energy Meters



Switch Disconnecter Fuse

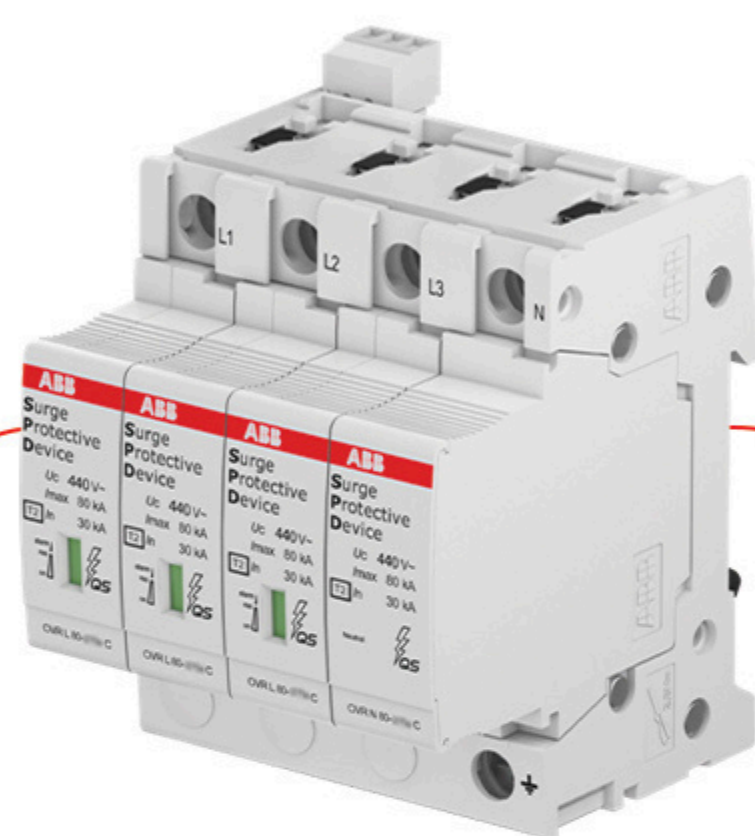

Surge Protection Devices

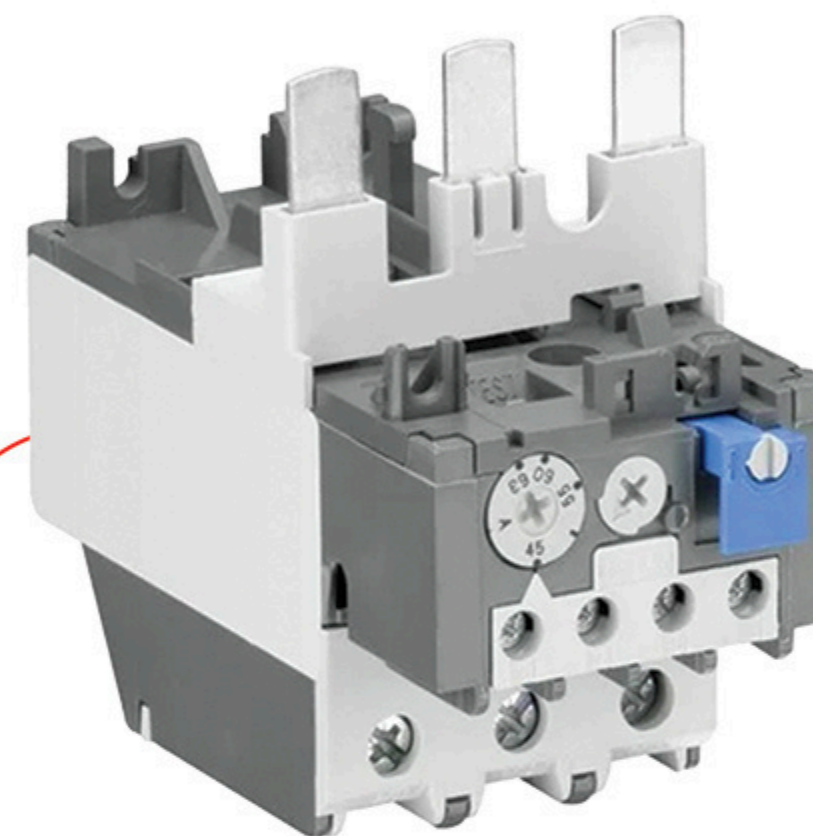

Contactors & Overload Relays



Distribution Boards

ELECTRICAL PANELS & JUNCTION BOXES

We offer robust **Nvent Hoffman** enclosure and panel solutions designed to protect critical electrical and automation systems in demanding industrial environments. From wall-mounted enclosures and junction boxes to climate control and panel accessories, Nvent Hoffman solutions enhance equipment protection, reliability and operational safety.

ELECTRICAL ENCLOSURES



Wall-Mounted Enclosures
(Single Door)



Free-Standing Enclosures
(Double Door)

TERMINAL BOXES



Stainless Steel Terminal
Boxes



Mild Steel Terminal
Boxes

LOW-VOLTAGE SWITCHGEARS

We provide advanced **Elmeasure** LV Switchgear, energy management and power monitoring solutions designed to improve energy efficiency, power quality and operational control. Multifunction meters and energy analyzers to smart monitoring systems, Elmeasure technologies help industries optimize energy usage, reduce downtime and achieve smarter power management.



**Air Circuit Breakers
(ACB)**



**Moulded case circuit
breaker (MCCB)**



EL guard



**Power Quality
Analyzer**



**Automatic Transfer
Switch (ATS)**



**Manual Transfer
Switch (MTS)**



Contactor



**Earth Leakage Relay
(ELR)**



**Earth Fault Relay
(EFR)**



Basic Meters

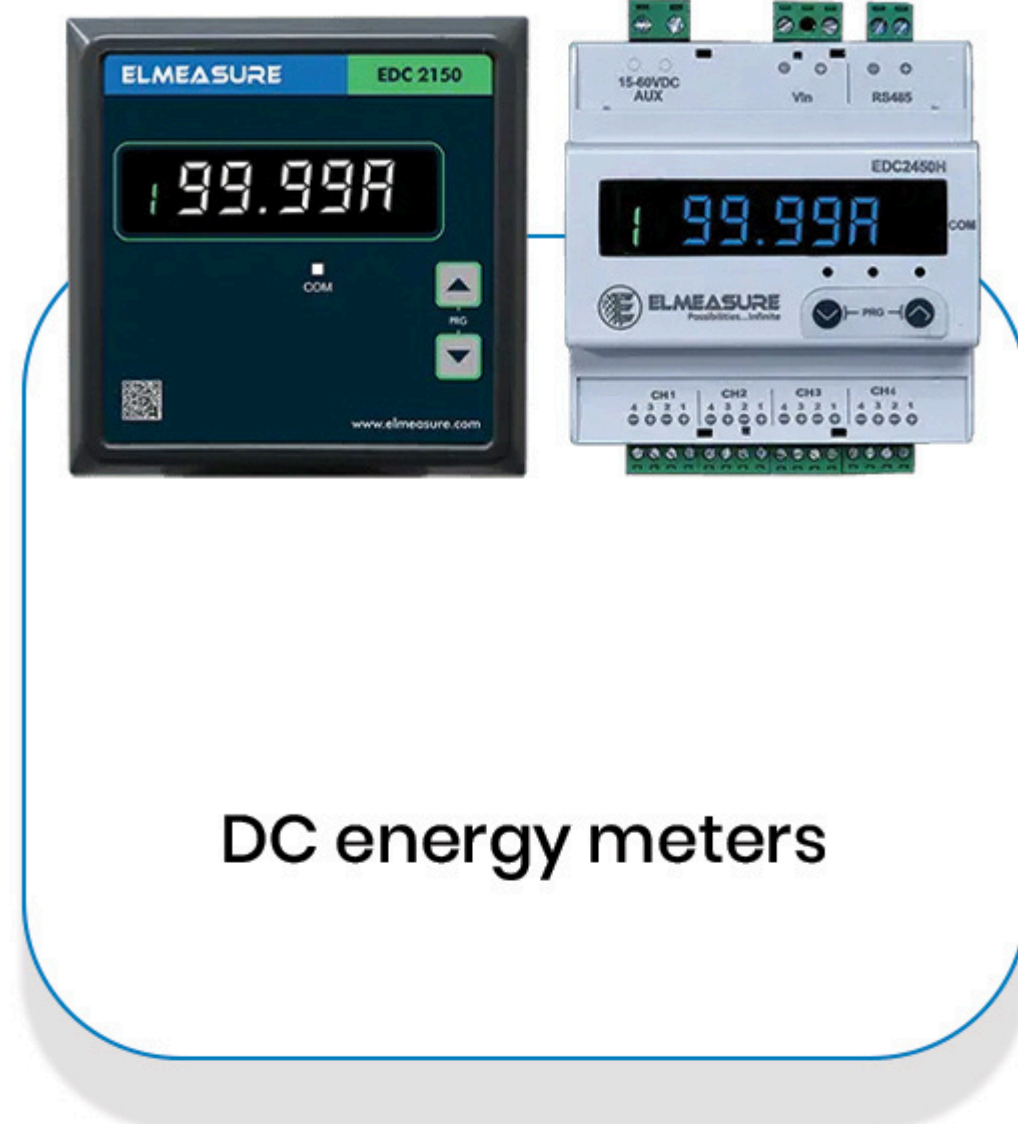

DC energy meters

CABLING ACCESSORIES

We provide a wide range of **Connectwell** terminal blocks and electrical connectivity solutions engineered for safe, organized and efficient panel wiring. From terminal blocks and interface modules to marking systems and accessories, Connectwell products ensure reliable electrical connections, simplified installation and long-term operational stability.

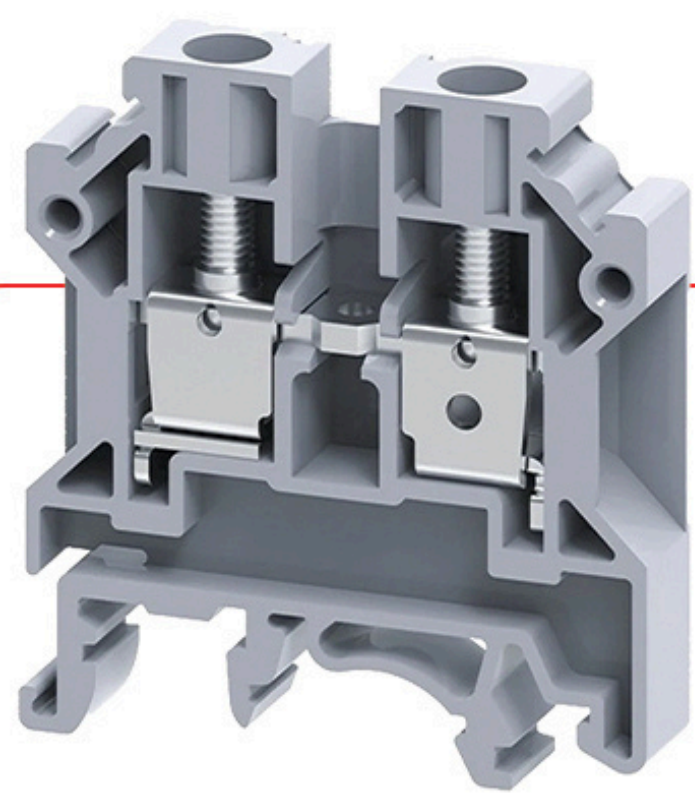

Terminal Blocks



Cable Glands & Accessories



Polyamide Flexible Conduit

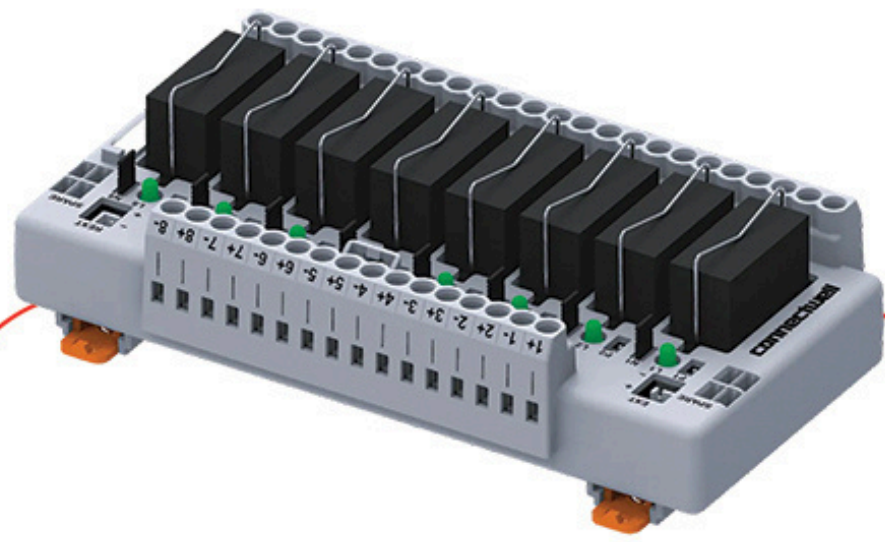

Relay Card



Multipole Industrial Connectors



Explosion Proof Double Compression

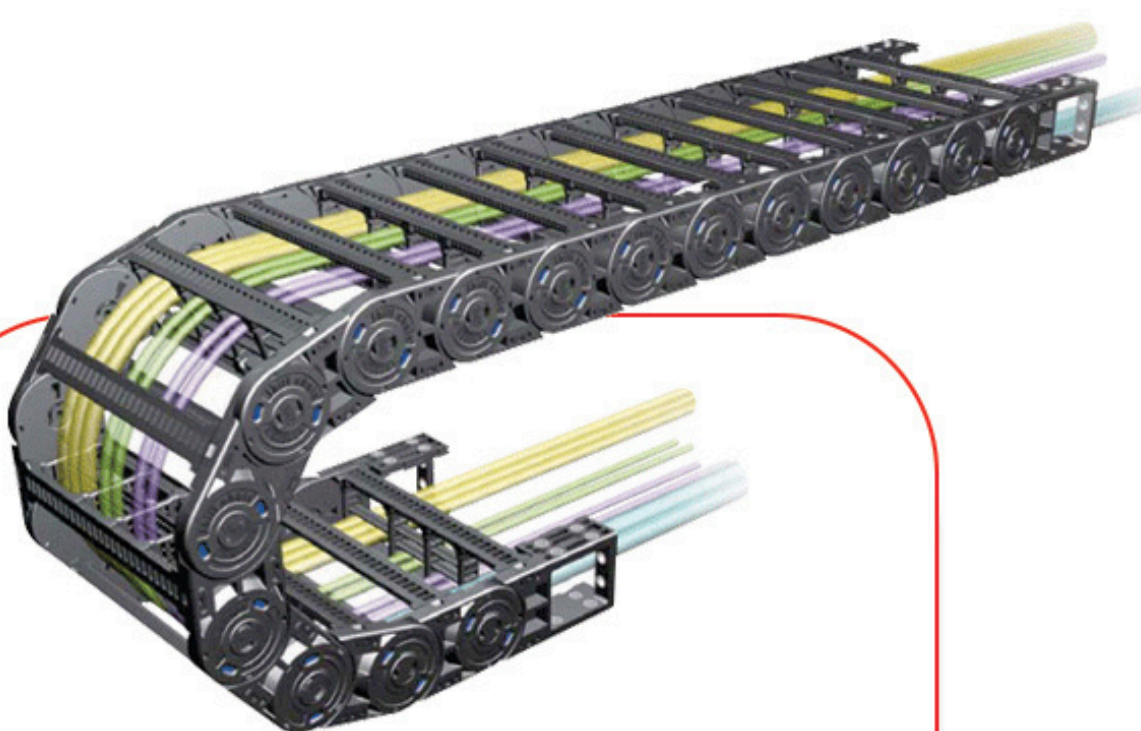

Cable Drag Chains

INDUSTRIAL CONNECTIVITY & CABLE SOLUTIONS

We offer high-quality **Trinity Touch** wiring accessories and electrical connection solutions designed for safe, durable and efficient installations. From cable ties and ferrules to glands, lugs and panel accessories, Trinity Touch products ensure dependable connectivity, easy maintenance and enhanced electrical performance.

TRIBOX®

Aluminium Enclosures

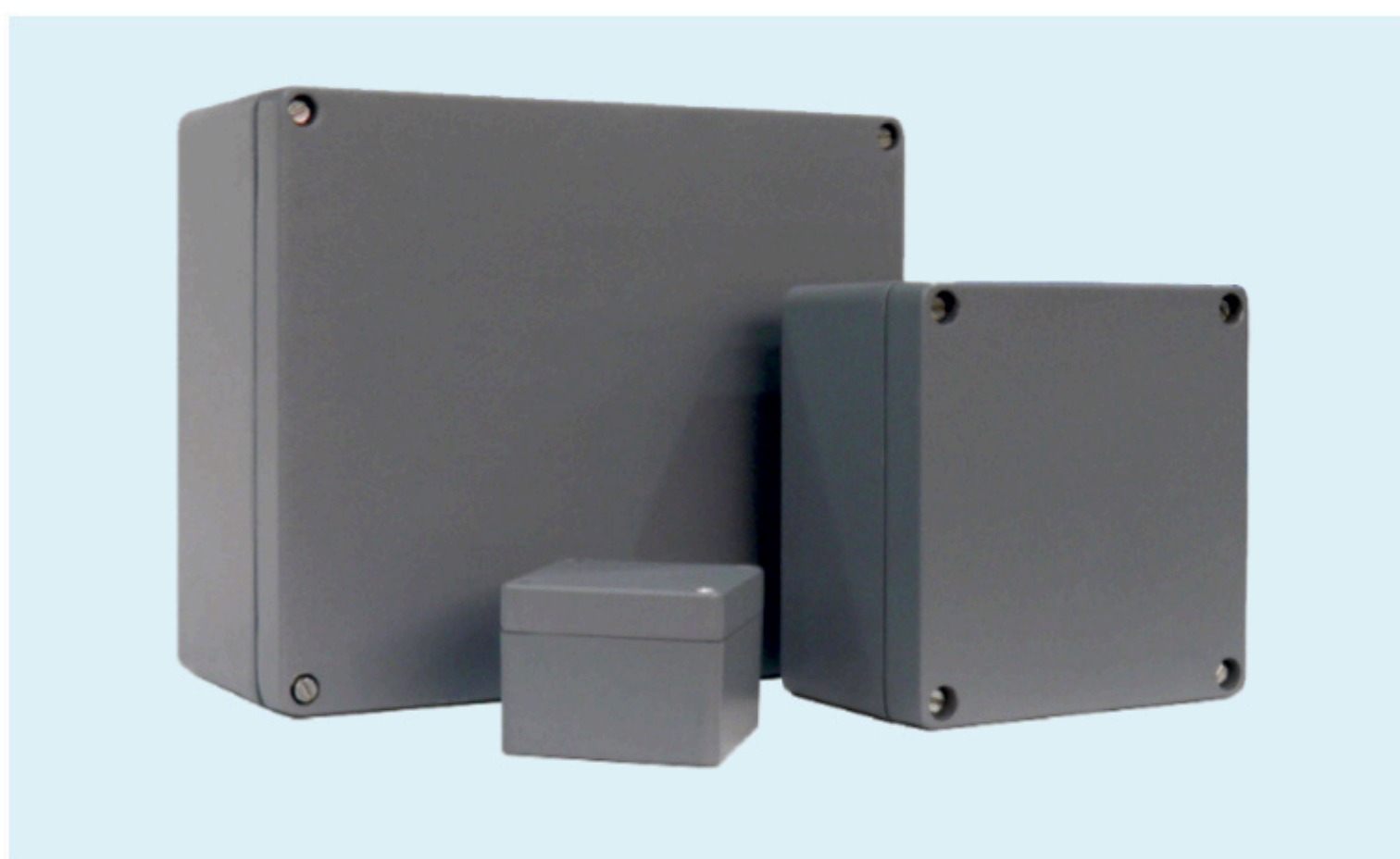

TRIBOX®

FRP Enclosures



TRIBOX®

Thermoplastic Enclosures



TRIBOX®

Customised Solutions

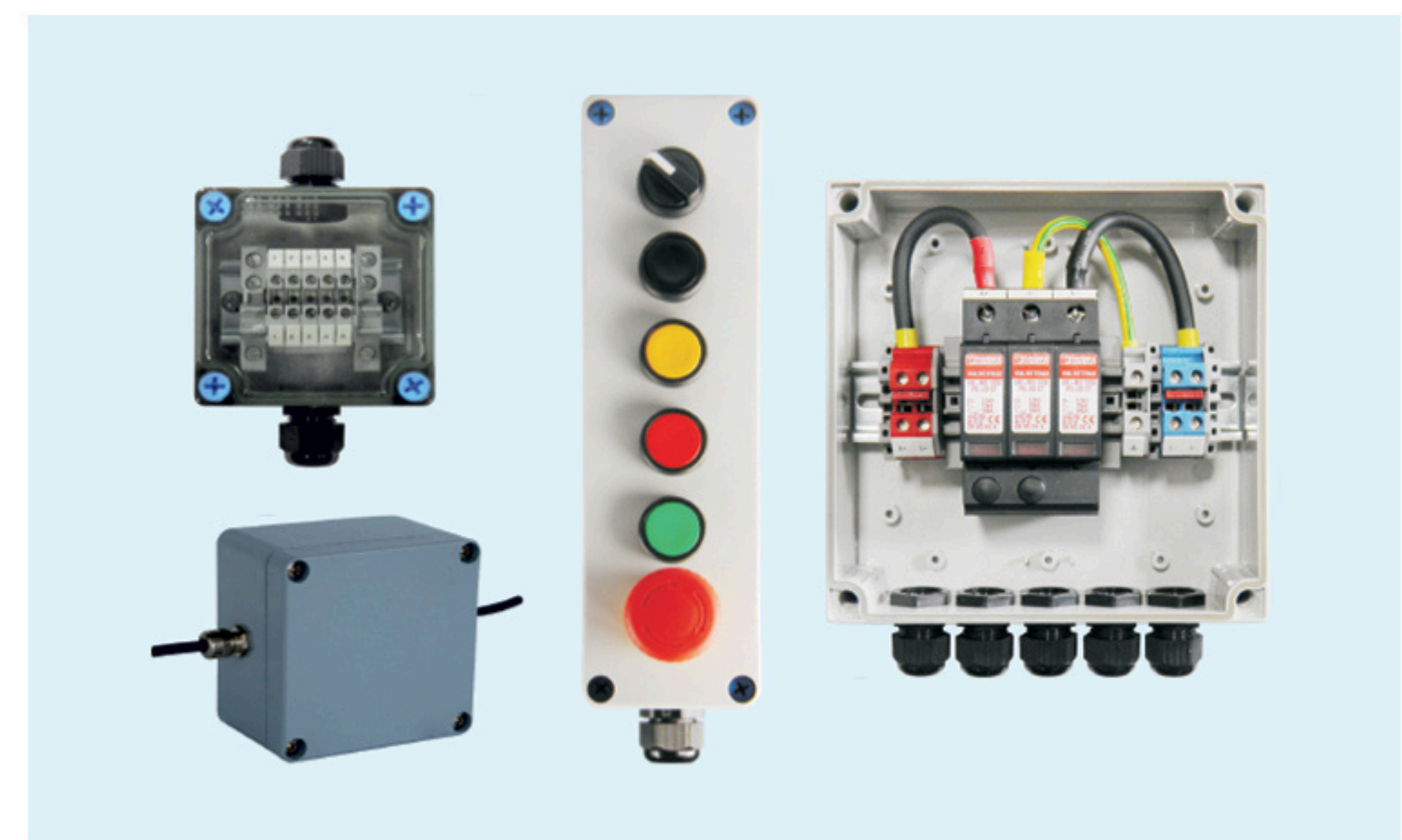

INDUSTRIAL CONTROLLERS

Analog Timers & Digital Timers



INDUSTRIAL CONTROLLERS

Temperature Controller & Switch Mode Power Supply



TRICHARGE®

E-Mobility Charging Connectors



TRIFLEX®

Flexible Conduits



DIN Rails

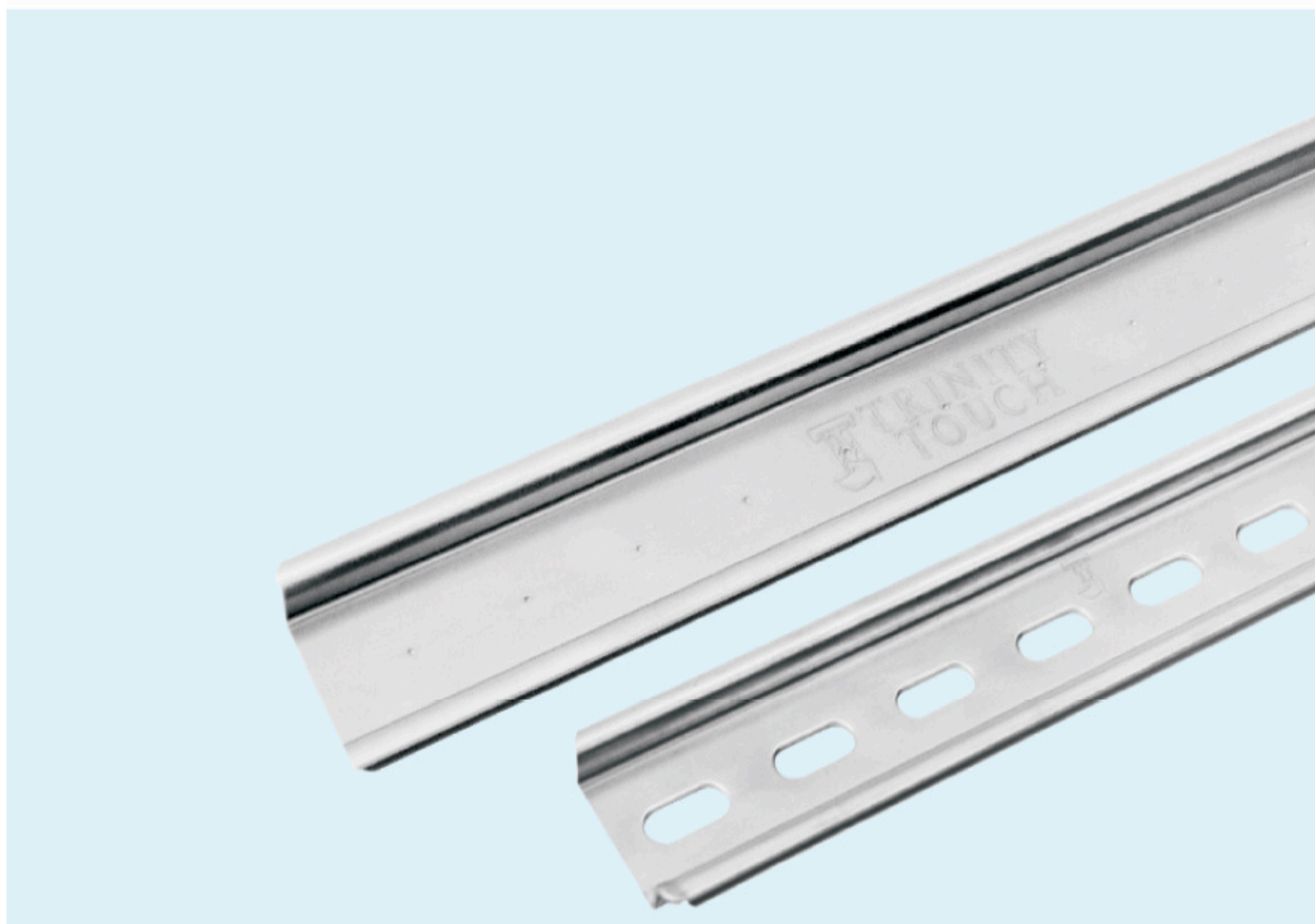

PVC Wiring Ducts

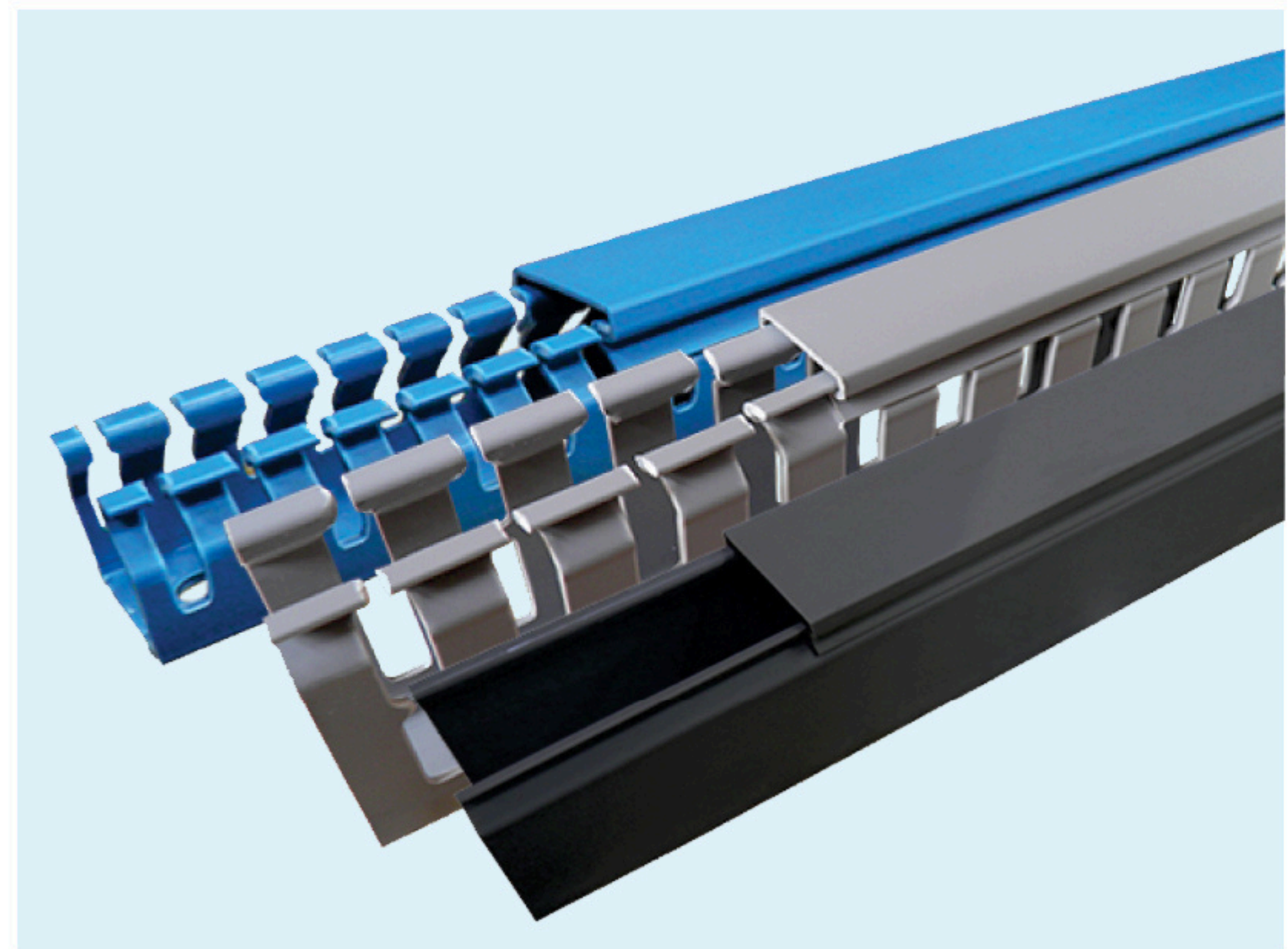

Halogen Free Wiring Ducts

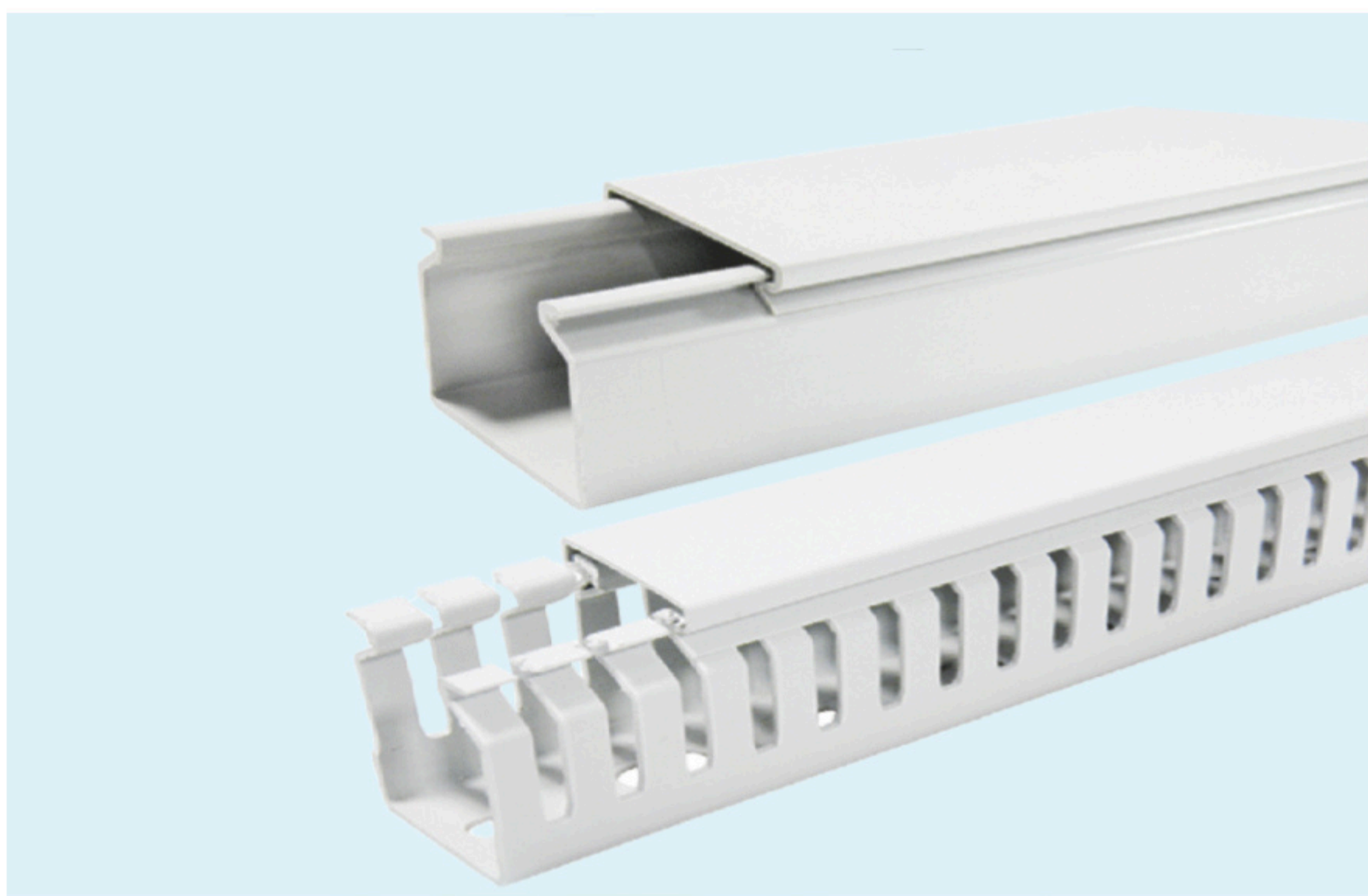

Solderless Terminals



Cable Glands



IP68 RoHS Us CE EN 45545

Industrial Plugs & Sockets



IP44 / 67 CE IEC 60309-1 IEC 60309-2

Interface Modules

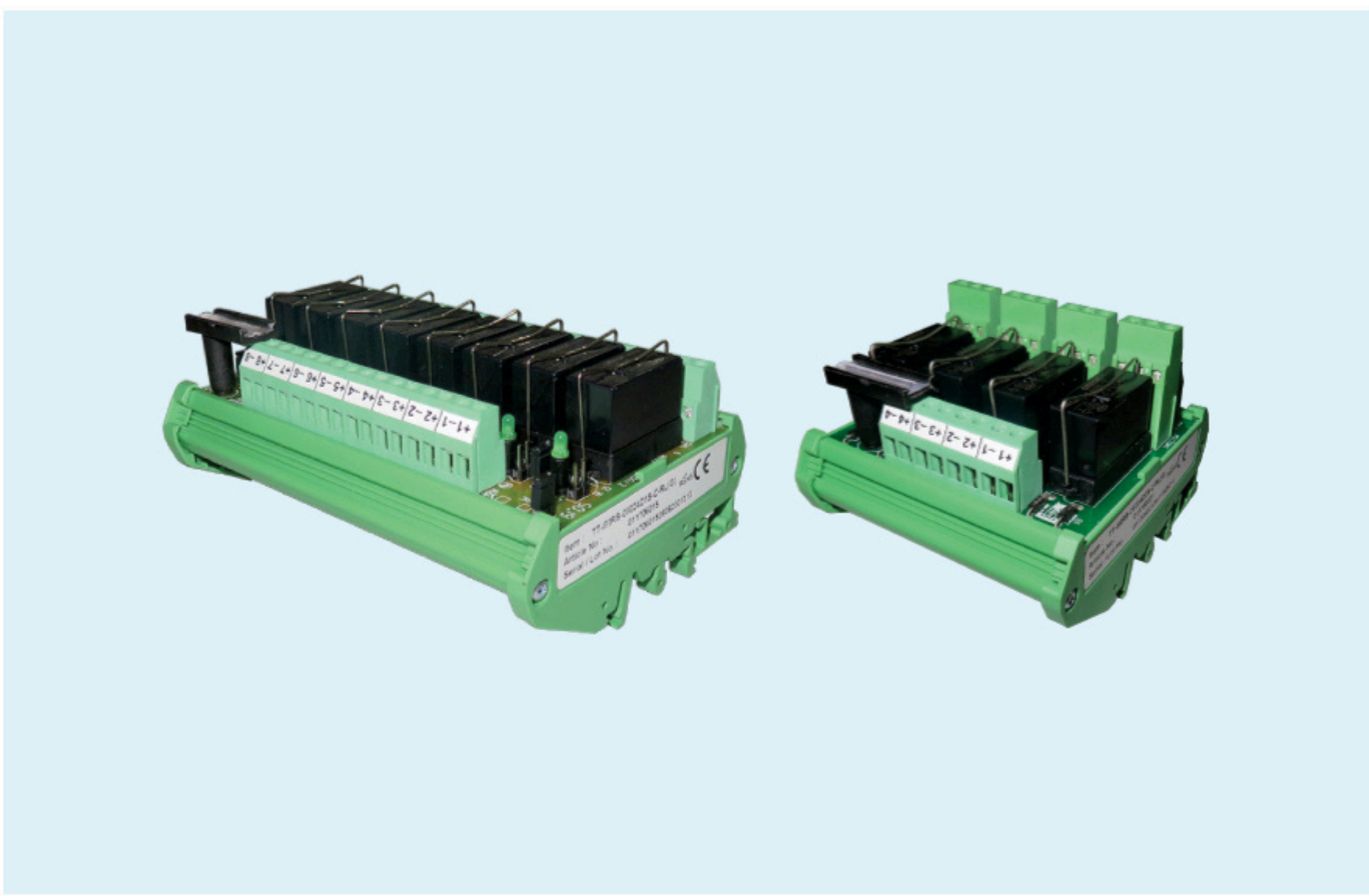

CE RoHS



INDUSTRIAL AUTOMATION

We offer a comprehensive range of **Telemecanique Sensors** solutions designed to deliver accurate detection, reliable monitoring and efficient automation across industrial applications. From proximity and photoelectric sensors to safety switches and control devices, Telemecanique technologies help improve machine safety, operational reliability and overall system performance.



Limit Switch



Inductive Sensors & Capacitive Sensors



Photoelectric Sensors

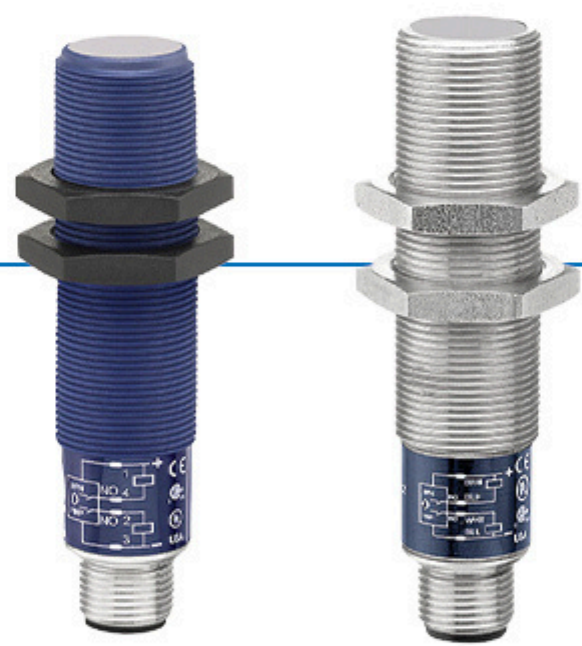

Ultrasonic Sensors



Pressure sensors



Safety sensors & switches



RFID and Inductive Identification Systems



Cordsets and connectors

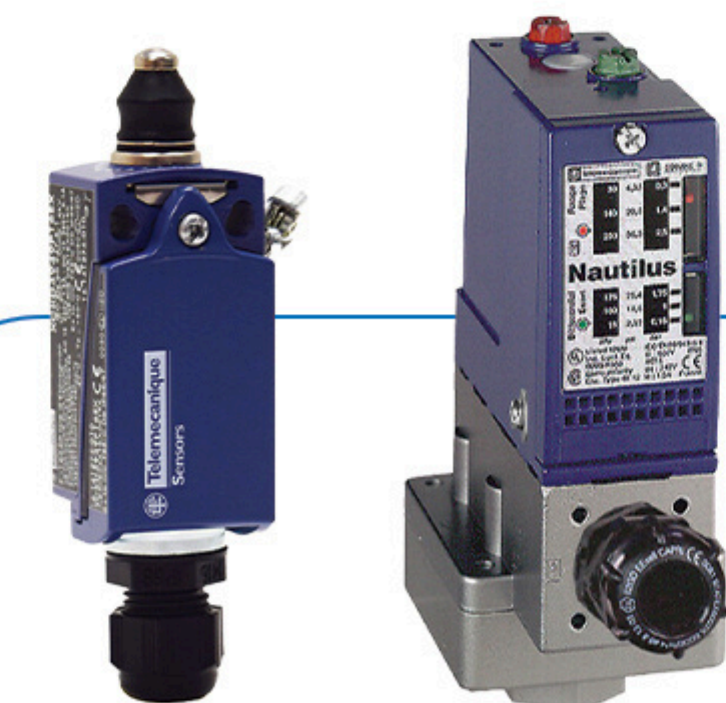

Hazardous dust location switches and sensors

NEW AGE TECHNOLOGY FOR INTEGRATED PANEL MANUFACTURING SOLUTION.

Balaji Switchgears new age **Gyanomation Systems**, a new business vertical for integrated Panel Manufacturing solutions that include PLC and VFD Panels, MCC & PCC, DOL Starters & Star-Delta Starters, Distribution Boards, and Junction Boxes. The panels are designed to address the challenges posed by multiple industries that need Environment Monitoring Systems, Poultry Equipments, Extruder / Extrusion Plants, Leading Machines OEMs, and SPM Manufacturers etc.

The integrated panels provide the best value for money. As we use globally renowned components like Panels from nVent HOFFMAN, Switchgear from Schneider Electric, Omron, Wires & Accessories from LAPP & Connectwell, thus adding efficiency and safety to the performance.



INDUSTRIES CATERED

- Environment Monitoring System
- Poultry Equipment
- Extruder/Extrusion Plants
- Leading Machine OEMS
- SPM Manufacturers
- Buildings

TYPES OF SOLUTION MANUFACTURED

PLC Panels | VFD Panels | MCC & PCC Panels | DOL Starters & Star-Delta Starters | Distribution Boards | Junction Boxes

FEW KEYS CLIENTS

Talwandi Sabo Power Plant | GE | ALSTOM | IIT | ICRISAT | CSIR Palampur | Schneider Electric

ANNUAL MAINTENANCE CONTRACTS (AMC)

Balaji Switchgears provides comprehensive Annual Maintenance Contracts (AMC) designed to maximize equipment uptime, enhance system reliability, and minimize unexpected breakdowns. Through preventive maintenance, periodic inspections, diagnostics, and technical support, ensuring the efficient performance of electrical and automation systems while extending equipment life and reducing operational costs.



RETROFITTING SOLUTIONS

Modernize your existing electrical infrastructure without the cost of complete replacement. **Balaji Switchgears** offers customized retrofitting solutions that enhance safety, efficiency, and system performance by upgrading outdated components, improving functionality, and ensuring compatibility with modern industrial requirements.

PROGRAMMING, COMMISSIONING & AUTOMATION SOLUTIONS

From system design to successful deployment, **Balaji Switchgears** provides end-to-end programming, commissioning, and automation services. Our expertise in PLC, HMI, SCADA, VFD and automation systems ensure seamless integration with custom-made programs developed by professionals. Ensuring you optimized control, productivity and reliable operations across wide range of industrial applications.

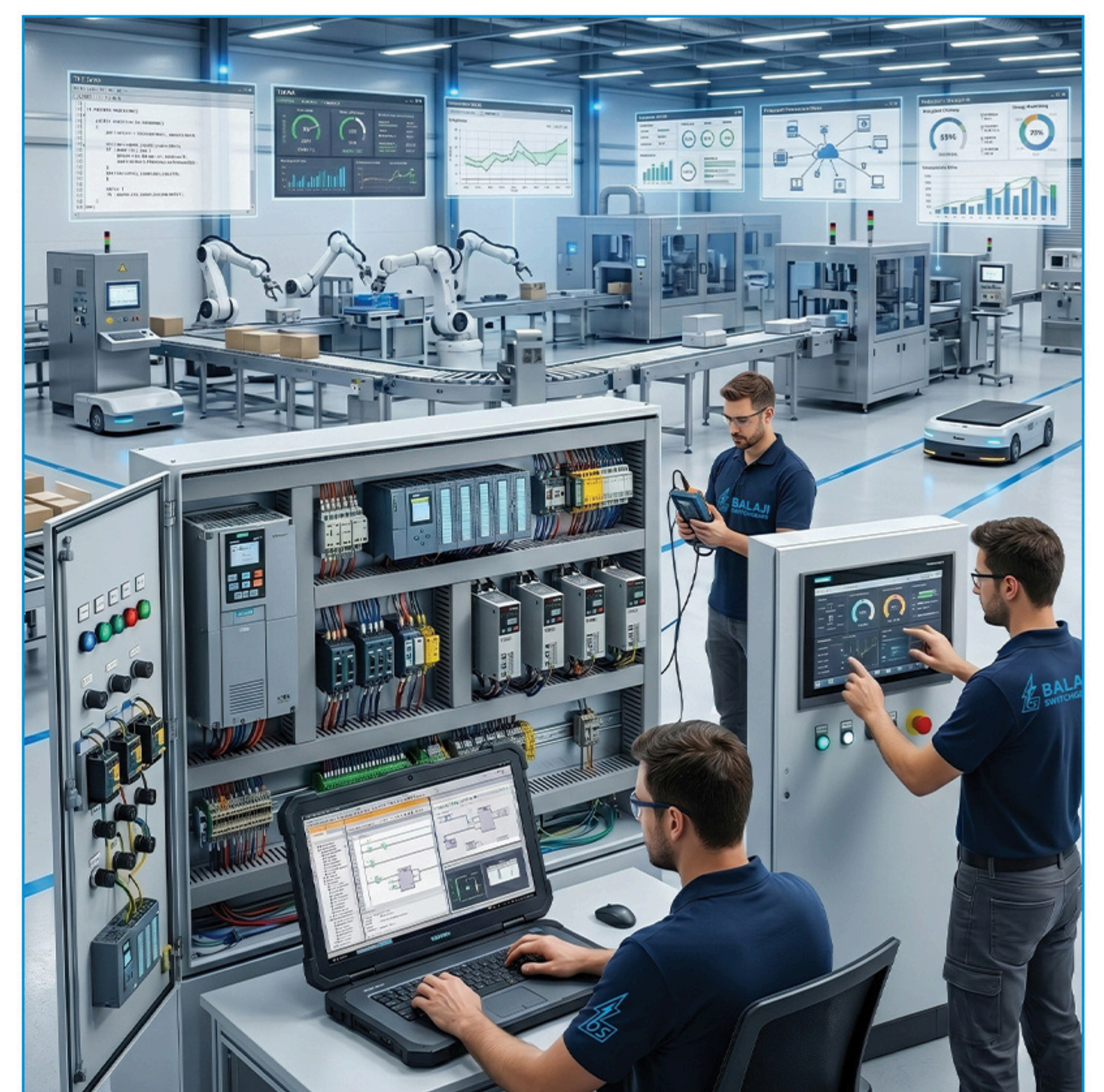



Head Office:

2006, Katra Lachhu Singh, Bhagirath Palace, Delhi-110006
Contact :- 011-41100313/0314, 011-23860986/3969

Marketing Office:

Plot No. 70, Building No. A-13, Rama Road, Near Kirti Nagar
Metro Station, Delhi-110015

Contact :- 011-44755186/187/188, 011-47093969
Email :- mktgindia@balajiswitchgears.com

Certifications



Follow us On

