



 PriceList

Switching and Controlling Products

With effect from January 17th, 2024



EasyPact TVS

> EasyPact TVS Power Contactors (3 Pole)	07
> EasyPact TVS Power Contactors (4 Pole)	08
> EasyPact TVS Contactor Accessories.....	09
> EasyPact TVS Thermal Overload Relay.....	10
> EasyPact TVS Circuit Breaker for Motor Protection.....	11

TeSys Control

> TeSys K Control Relays	17
> TeSys K Power Contactors	17
> TeSys K Accessories.....	18
> TeSys Capacitor Duty Contactor	19
> TeSys Deca Control Relays	20
> TeSys Deca Power Contactors (3 Pole).....	20
> TeSys Deca Power Contactors (4 Pole).....	21
> TeSys Deca Green Electronic Coil Contactor	23
> TeSys Deca Accessories.....	24
> TeSys Giga Power Contactors.....	31
> TeSys Giga Accessories	32
> TeSys H – Hybrid Starter	34

TeSys Protect

> TeSys Overload Relay	37
> Electronic Over Current Relay.....	39

TeSys Power

> TeSys Motor Circuit Breakers	42
> Circuit Breakers for Motor Protection Accessories	43

TeSys Switches

> TeSys Switches.....	46
-----------------------	----

TeSys Active

> TeSys Island	48
> TeSys U	50
> TeSys T - iMCC Relays	52

Selection Table

> Type 2 Co-ordination Charts	54 to 57
> Type 2 Co-ordination chart with TeSys Giga range.....	58 to 61
> Type 2 Recommended Selection Charts	62 to 68



EasyPact TVS

Motor starter solutions from
6A to 630A



<https://www.se.com>

Life Is On

Schneider
Electric

EasyPact TVS

The Easy choice for simplicity and flexibility

- 3 Pole and 4 Pole Power Contactor
- Control Relays
- Thermal Overload Relay
- Circuit Breaker for Motor Protection
- Accessories

A2L certified
upto 50A
for HVAC
applications



HVAC



GenSet

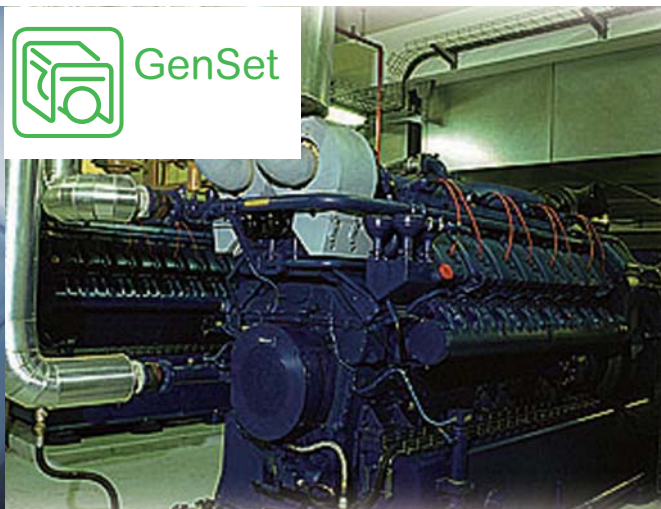

Pumps



Textile



Material
Handling



Packaging



EasyPact TVS

Power Contactors LC1E (3 Pole AC Control)



- Conformance to IEC 60947-4-1, CE Marking
- Current Rating: 6A to 630A, AC-3 Rating
- Type 2 RSC available with Fuse, MPCB and MCCB

Frame	[Ie] Rated Operational Current		Motor Power at 415V, 3Ph, 50Hz		Auxiliary Contacts		Reference	Unit MRP [₹]	
	AC-1	AC-3	HP	kW	NO	NC		M7 (220V)	N5 (415V)
FRAME-1	20 A	6 A	3	2.2	-	1	LC1E0601* <input checked="" type="checkbox"/>	1355	1600
	20 A	6 A	3	2.2	1	-	LC1E0610* <input checked="" type="checkbox"/>	1355	-
	25 A	9 A	5.5	4	-	1	LC1E0901* <input checked="" type="checkbox"/>	1390	1390
	25 A	9 A	5.5	4	1	-	LC1E0910* <input checked="" type="checkbox"/>	1390	1390
	25 A	12 A	7.5	5.5	-	1	LC1E1201* <input checked="" type="checkbox"/>	1585	1585
	25 A	12 A	7.5	5.5	1	-	LC1E1210* <input checked="" type="checkbox"/>	1585	1585
	32 A	18 A	12	9	-	1	LC1E1801* <input checked="" type="checkbox"/>	1830	1830
	32 A	18 A	12	9	1	-	LC1E1810* <input checked="" type="checkbox"/>	1830	1830
	36 A	25 A	15	11	-	1	LC1E2501* <input checked="" type="checkbox"/>	2495	2950
	36 A	25 A	15	11	1	-	LC1E2510* <input checked="" type="checkbox"/>	2495	2495
FRAME-2	50 A	32 A	20	15	-	1	LC1E3201* <input checked="" type="checkbox"/>	5225	6180
	50 A	32 A	20	15	1	-	LC1E3210* <input checked="" type="checkbox"/>	5225	5225
	50 A	38 A	25	18.5	-	1	LC1E3801* <input checked="" type="checkbox"/>	6175	7300
	50 A	38 A	25	18.5	1	-	LC1E3810* <input checked="" type="checkbox"/>	6175	6175
	50 A	40 A	29	22	-	1	LC1E40B01* <input checked="" type="checkbox"/>	6585	-
	50 A	40 A	29	22	1	-	LC1E40B10* <input checked="" type="checkbox"/>	6585	-
FRAME-3	60 A	40 A	29	22	1	1	LC1E40* <input checked="" type="checkbox"/>	8180	8180
	70 A	50 A	34	25/30	1	1	LC1E50* <input checked="" type="checkbox"/>	9950	9950
	80 A	65 A	50	37	1	1	LC1E65* <input checked="" type="checkbox"/>	13480	13480
FRAME-4	110 A	80 A	60	45	1	1	LC1E80* <input checked="" type="checkbox"/>	17530	17530
	120 A	95 A	60	45	1	1	LC1E95* <input checked="" type="checkbox"/>	21010	21010

Frame	[Ie] Rated Operational Current		Motor Power at 415V, 3Ph, 50Hz		Auxiliary Contacts		Reference	Unit MRP [₹]			
	AC-1	AC-3	HP	kW	NO	NC		M7 (220V)	N5 (415)	M5 (220V)	N7 (415)
FRAME-5	150 A	120 A	75	55	1	1	LC1E120*	-	25030	25030	-
	200 A	160 A	120	90	1	1	LC1E160*	-	33050	33050	-
FRAME-6	250 A	200 A	150	110	-	-	LC1E200*	-	45490	45490	-
	300 A	250 A	175	132	-	-	LC1E250*	-	70850	59945	-
FRAME-7	320 A	300 A	215	160	-	-	LC1E300*	-	73800	73800	-
	500 A	400 A	295	220	-	-	LC1E400*	92100	-	-	107810
FRAME-8	700 A	500 A	375	280	-	-	LC1E500*	129725	-	-	-
FRAME-9	1000 A	630 A	500	375	-	-	LC1E630*	182485	-	-	215590

For other coil voltage ratings contactors, please contact Customer Care.

* Reference to be completed by adding coil voltage code

For details on non standard references, technical parameters, accessories, compatibility, stockable and non stockable status please contact Customer Care

NORMAL STOCK ITEMS

W.E.F. January 17th, 2024

EasyPact TVS

Power Contactors - ETVS (4 Pole AC Control)



- Conformance to IEC 60947-4-1, CE Marking
- Current Rating: 20A to 125A, AC-1 rating
- Available in 4NO and 2NO+2NC Power Pole combination
- Wide Band Coil for all ratings in 220 & 415V AC

Frame	AC-1 Rating	Power Poles	Reference	F7 (110V)	M5WB (220V)	N5WB (415V)
FRAME-1	20	4NO	LC1E06004*IN	2055	1730	-
	25	4NO	LC1E09004*IN	2175	1835	2175
	32	4NO	LC1E12004*IN	-	1910	-
	40	4NO	LC1E18004*IN	2380	2380	2380
FRAME-2	50	4NO	LC1E25004*IN	-	3015	3015
	55	4NO	LC1E32004*IN	-	5090	-
	60	4NO	LC1E38004*IN	5955	5955	5955
FRAME-3	75	4NO	LC1E40004*IN	11230	9280	11230
	85	4NO	LC1E65004*IN	15190	12555	12555
FRAME-4	110	4NO	LC1E80004*IN	19240	15905	-
	125	4NO	LC1E95004*	-	17935	-

Frame	AC-1 Rating	Power Poles	Reference	F7 (110V)	M5WB (220V)	N5WB (415V)
FRAME-1	20	2NO + 2NC	LC1E06008*IN	-	2065	-
	25	2NO + 2NC	LC1E09008*IN	2225	2225	2225
	32	2NO + 2NC	LC1E12008*IN	2835	2380	-
	40	2NO + 2NC	LC1E18008*IN	2395	2395	-
FRAME-2	50	2NO + 2NC	LC1E25008*IN	4285	4285	5090
	60	2NO + 2NC	LC1E38008*IN	8420	8420	-
FRAME-3	75	2NO + 2NC	LC1E40008*IN	-	12475	15085
	85	2NO + 2NC	LC1E65008*IN	15595	15595	-
FRAME-4	110	2NO + 2NC	LC1E80008*IN	-	22145	-

For other coil voltage ratings contactors, please contact Customer Care.

* Reference to be completed by adding coil voltage code

Control Relays - CAE,

Conformance to IEC60947-5-1, CE Marking

Auxiliary Contacts			Reference				Unit MRP [₹]				
NO	NC	CAE40*	B5	F5	M5	N5	CAE31*	B5	F5	M5	N5
4	0	CAE40*	1725	1440	1440	1440	1725	1725	1440	1440	1725
3	1	CAE31*	1725	1440	1440	1440	1725	1440	1440	1440	1725
2	2	CAE22*	1725	1440	1440	1440	1725	1440	1440	1440	1725

* Reference to be completed by adding coil voltage code and recommended to check availability with Customer Care team

Spare Coil for Contactors

Contactor	Reference
4 Pole Contactors	
LC1E0600*.... LC1E1800*	LAEX1T**
LC1E2500*.... LC1E3800*	LAEX2T**
LC1E4000*....LC1E9500*	LAEX4T**
Control Contactors	
CAE*	LAEX12**

* Reference to be completed by adding coil voltage code and recommended to check availability with Customer Care team

For details on non standard references, technical parameters, accessories, compatibility, stockable and non stockable status please contact Customer Care

NORMAL STOCK ITEMS

W.E.F. January 17th, 2024

Accessories - For ETVS Contactors

Description	For Use with	Mounting	Contacts	Reference	Unit MRP [₹]
Auxiliary contact block	LC1E06..E630 & LC1E0600..E9500	FRONT	1NO+1NC	LAEN11 <input checked="" type="checkbox"/>	425
		FRONT	2NO	LAEN20 <input checked="" type="checkbox"/>	425
		FRONT	2NC	LAEN02 <input checked="" type="checkbox"/>	505
		FRONT	2NO+2NC	LAEN22 <input checked="" type="checkbox"/>	775
		FRONT	4NO	LAEN40 <input checked="" type="checkbox"/>	775
Star delta timer	LC1E25..E630			LAETSD <input checked="" type="checkbox"/>	3510

Description	For Use with	Coil Voltage	Reference	Unit MRP [₹]
Surge suppressor*	LC1E06...E95	24..48V AC	LAERCE	2320
	LC1E06...E95	110..240V AC	LAERCU	985

*For higher rating contactors, contact Customer Care

Description	For Use with	Reference	Unit MRP [₹]
Mechanical Interlock	LC1E06..E65 & LC1E0600*..E3800*	LAEM1	880
	LC1E80/E95 & LC1E4000*...LC1E9500*	LAEM4	2860
	LC1E120..E160	LAEM5	5335
	LC1E200/E250	LAEM6	5440

*Reference to be completed by adding coil voltage

3 Pole Accessories Compatibility

Contactor	Built in contacts	LAEN**	LAERC*	LAEM
LC1E06	1NO or 1NC	1	1	1
LC1E09				
LC1E12				
LC1E18				
LC1E25				
LC1E32				
LC1E38	1NO + 1NC	1	-	1
LC1E40B				
LC1E40				
LC1E50				
LC1E65				
LC1E80				
LC1E95	-	2	-	-
LC1E120				
LC1E160				
LC1E200				
LC1E250				
LC1E300				
LC1E400	-	2	-	-
LC1E500				
LC1E630				

4 Pole Accessories Compatibility

Contactor	LAEN**	LAEM	LAERC*
LC1E06	1	1	1
LC1E09			
LC1E12			
LC1E18			
LC1E25			
LC1E32			
LC1E38			
LC1E40			
LC1E50			
LC1E65			
LC1E80			
LC1E95			

Control Relay Accessories Compatibility

Control Relay	LAEN*	LAERC
CAE	1 of LAEN11 or LAEN20 or LAEN02 or LAEN22	1

For details on non standard references, technical parameters, accessories, compatibility, stockable and non stockable status please contact Customer Care

NORMAL STOCK ITEMS

W.E.F. January 17th, 2024

EasyPact TVS

Thermal Overload Relay - ETVS



- Conformance to IEC 60947-4-1, CE Marking
- Range : 0.1A to 630A
- Tripping Class : 10A
- Direct & Independent mounting

Thermal Protection Adjustment Range	For Use with Contactor	Reference	Unit MRP [₹]
LRE			
0.25...0.4	E06...E38	LRE03	2285
0.4...0.63	E06...E38	LRE04	2285
0.63...1	E06...E38	LRE05 <input checked="" type="checkbox"/>	2285
1...1.6	E06...E38	LRE06 <input checked="" type="checkbox"/>	2285
1.6...2.5	E06...E38	LRE07 <input checked="" type="checkbox"/>	2285
2.5...4	E06...E38	LRE08 <input checked="" type="checkbox"/>	2285
4...6	E06...E38	LRE10 <input checked="" type="checkbox"/>	2285
5.5...8	E09...E38	LRE12 <input checked="" type="checkbox"/>	2285
7...10	E09...E38	LRE14 <input checked="" type="checkbox"/>	2285
9...13	E12...E38	LRE16 <input checked="" type="checkbox"/>	2285
12...18	E18...E38	LRE21 <input checked="" type="checkbox"/>	2530
16...24	E25...E38	LRE22 <input checked="" type="checkbox"/>	2925
23...32	E25...E38	LRE32 <input checked="" type="checkbox"/>	3910
30...38	E38	LRE35 <input checked="" type="checkbox"/>	4405
17...25	E40...E95	LRE322	4970
23...32	E40...E95	LRE353	4970
30...40	E40...E95	LRE355	4970
37...50	E50...E95	LRE357 <input checked="" type="checkbox"/>	4970
48...65	E65...E95	LRE359	6520

Thermal Protection Adjustment Range	For Use with Contactor	Reference	Unit MRP [₹]
LRE			
55...70	E80...E95	LRE361	7725
63...80	E80...E95	LRE363	8065
80...104	E95	LRE365	8065
51...81	E120...E300	LRE480	15105
62...99	E120...E300	LRE481	15105
84...135	E120...E300	LRE482	15105
124...198	E160...E300	LRE483	15105
146...234	E200...E300	LRE484	15105
174...279	E250...E300	LRE485	15105
208...333	E300	LRE486	16460
258...414	E300...E400	LRE487	20025

Accessories for Relay

Accessory	For Relay	Reference	Unit MRP [₹]
Separate Mounting Block	LRE01...LRE35	LAEB1	795
	LRE322...LRE365	LAEB3	1830

For details on non standard references, technical parameters, accessories, compatibility, stockable and non stockable status please contact Customer Care

NORMAL STOCK ITEMS

W.E.F. January 17th, 2024

EasyPact TVS

Circuit Breaker for Motor Protection - GZ1E - Pushbutton control



- Conformance to IEC60947-1,-2,-4, CE Marking
- Range : 0.1A to 32A
- Breaking Capacity upto 100KA

Motor Protection Circuit Breaker - ETVS

Breaking Capacity at 415 V 50 Hz	Motor Power AC3**		Thermal Protection Adjustment Range (A)	Reference	Unit MRP [₹]
	kW	hP			
GZ1-E Thermal Magnetic - With Pushbutton Control					
100 kA	-	-	0.1 - 0.16	GZ1E01	4130
	0.06	-	0.16 - 0.25	GZ1E02	4130
	0.09	-	0.25 - 0.40	GZ1E03	4130
	0.18	-	0.40 - 0.63	GZ1E04	4810
	0.37	0.5	0.63 - 1.0	GZ1E05	4810
	0.55	0.75	1.0 - 1.6	GZ1E06	4710
	0.75	1	1.6 - 2.5	GZ1E07	4710
	1.1	2	2.5 - 4	GZ1E08	4895
	2.2	3	4 - 6.3	GZ1E10	4895
	3	5.5	6 - 10	GZ1E14	5215
10 kA*	5.5	7.5	9 - 14	GZ1E16	5880
	7.5	10	13 - 18	GZ1E20	6395
	9	12.5	17 - 23	GZ1E21	6740
	11	15	20 - 25	GZ1E22	7080
	15	20	24 - 32	GZ1E32	12635

Breaking Capacity at 415 V 50 Hz	Motor Power AC3**		Magnetic Protection (A)	Reference	Unit MRP [₹]
	kW	hP			
GZ1-LE Magnetic- With Pushbutton Control					
	0.37	0.5	1	GZ1LE05	3015
	0.55	0.75	1.6	GZ1LE06	3015
	0.75	1	2.5	GZ1LE07	3015
	1.1	2	4	GZ1LE08	3015
	2.2	3	6.3	GZ1LE10	3015
	3	5.5	10	GZ1LE14	3015
10 kA*	5.5	7.5	14	GZ1LE16	3260
	7.5	10	18	GZ1LE20	3260
	11	15	25	GZ1LE22	3260
	15	20	32	GZ1LE32	3865

* 50kA With current Limiter type GV1L3

Accessories - ETVS Circuit Breaker for Motor Protection

Description	Mounting	Contacts	Reference	Unit MRP [₹]
Auxillary Contact Block	LH side Mounted	1NO+1NC	GZ1AN11	775
		2NO	GZ1AN20	1005

For details on non standard references, technical parameters, accessories, compatibility, stockable and non stockable status please contact Customer Care

NORMAL STOCK ITEMS

W.E.F. January 17th, 2024



Green Premium™

An industry leading portfolio of offers delivering sustainable value



More than 75% of our product sales offer superior transparency on the material content, regulatory information and environmental impact of our products:

- RoHS compliance
- REACh substance information
- Industry leading # of PEP's*
- Circularity instructions



Discover what we mean by green
Check your products!

The Green Premium program stands for our commitment to deliver customer valued sustainable performance. It has been upgraded with recognized environmental claims and extended to cover all offers including Products, Services and Solutions.

CO₂ and P&L impact through... Resource Performance

Green Premium brings improved resource efficiency throughout an asset's lifecycle. This includes efficient use of energy and natural resources, along with the minimization of CO₂ emissions.

Cost of ownership optimization through... Circular Performance

We're helping our customers optimize the total cost of ownership of their assets. To do this, we provide IoT-enabled solutions, as well as upgrade, repair, retrofit, and remanufacture services.

Peace of mind through... Well-being Performance

Green Premium products are RoHS and REACh compliant. We're going beyond regulatory compliance with step-by-step substitution of certain materials and substances from our products.

Improved sales through... Differentiation

Green Premium delivers strong value propositions through third-party labels and services. By collaborating with third-party organizations we can support our customers in meeting their sustainability goals such as green building certifications.



TeSys

> Control > Protect > Power > Active

Innovative and connected solutions for motor starters

TeSys is an innovative motor control and management solution from the global market leader. TeSys offers connected, efficient products and solutions for switching and protection of motors and electrical loads in compliance with all major global electrical standards

TeSys Function Names

TeSys components are grouped by function name, for easier identification. These functions are related to motor, power, control and protection.

> TeSys Power:

Components for powering motors



> TeSys Control:

Components for controlling motors



> TeSys Protect:

Components for protecting motors

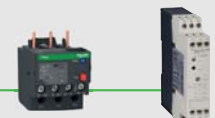

> TeSys Active:

Connected components for motor circuits



Start smart. Run smart. With TeSys motor controls.



Stay smart with the world's best-selling motor control solutions from the inventor of the world's first contactor - Schneider Electric™.

For almost a century, TeSys motor controls have driven the industry with innovations in motor protection, monitoring, and control.

It started with the introduction of the industry's first BAR contactor in 1924, and today, the legacy of innovation is built into every TeSys motor control device.

Best-in-class safety and reliability, plug-and-play architecture, and flexible functionality mean TeSys motor control solutions can meet your requirements across a wide range of applications, from the most common to the most advanced.

Wherever you are and anywhere your projects come together, you can trust Schneider Electric and TeSys contactors, circuit breakers, relays, and switches for unmatched reliability, complete compatibility with international standards, and the robust support of the Schneider Electric global supply network.

A Century of Innovation and Leadership

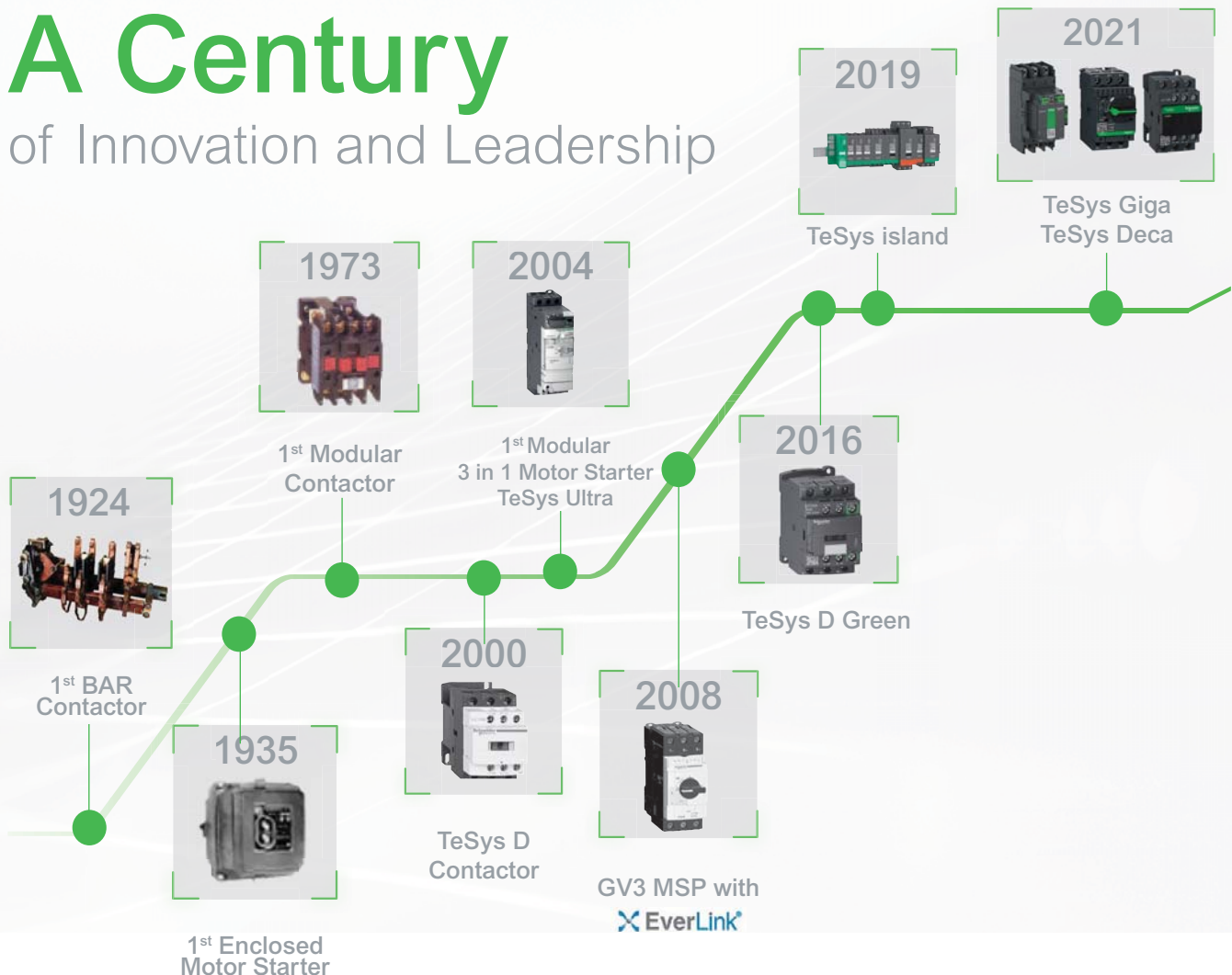

Superior safety for all industries

TeSys motor controls come with all of the isolation, protection and emergency handling you need to comply with international codes. High-contrast covers identify safety-critical devices to prevent inadvertent manual operation. Every TeSys contactor is both mechanically linked and equipped with mirror contacts for safety applications and wherever auxiliary contact state reliability is critical.



HVAC

Ensure 24/7 availability of your HVAC system with reliable products that can reach high ambient temperatures without derating.



Conveying

Decentralize the control cabinet of your conveyor line and benefit from up to 80% space reduction.



Genset

Make certain your generator starts even in the harshest conditions with robust TeSys solutions.



Pumping

Optimize single or multi-drive boosters for industry or infrastructure with energy and cost-effective solutions.



Packaging

Keep pace with the most demanding, high-end packing applications with solutions that can perform 30 million AC53a electrical cycles, like TeSys H.

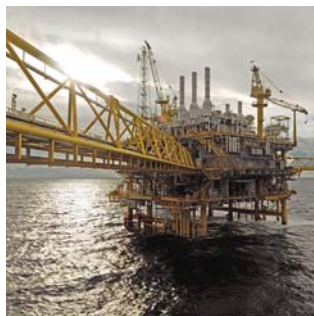

Oil and Gas

Keep your employees and assets safe and improve uptime in onshore and offshore applications: pipeline operations: LNG and natural gas processing: and refining and petrochemical applications.



Water and Wastewater

Optimize the treatment and delivery of safer water by reducing energy usage and lowering operating costs.

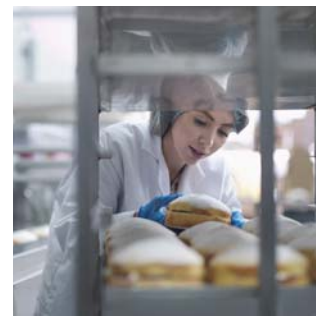

Food and Beverage

Serve your customers with environmentally friendly products to improve sustainability, efficiency, and flexibility, allowing you to adapt to changing customer habits.

Online selection tool

EcoStruxure™ Motor Control Configurator

For Direct-On-Line and Star-Delta starters, motor circuit breakers with advanced protection, motor management relays, configurations for total coordination, drives, and soft starters.

No matter what kind of starting method you need, our online EcoStruxure™ Motor Control Starter Configurator will help you to quickly and easily select the optimal combination of components to ensure maximized motor safety, protection, and uptime.

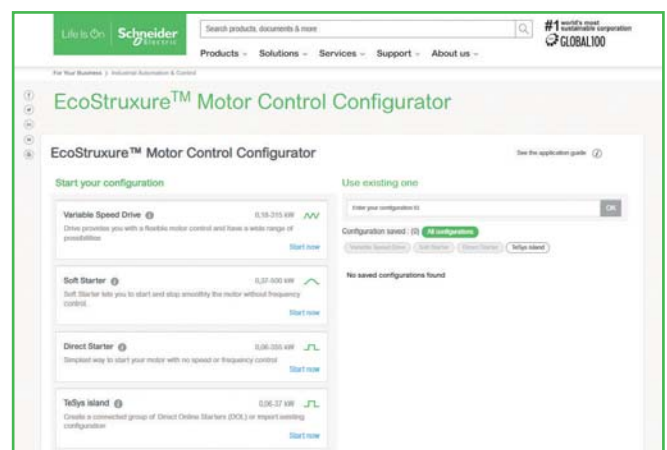

Scan or click on
the QR code

TeSys Range

TeSys Component Series Names

Series names are now grouped as per the current ratings

- Series names group conventional components (circuit breakers, contactors, relays, overcurrent relays) by current rating ranges.
 - 0 to 16 A > **TeSys K** Series
 - 9 to 150 A > **TeSys 'Deca'** Series
 - 185 to 800 A > **TeSys 'Giga'** Series.
- TeSys advanced components have a specific classification.
 - 0 to 38 A All-in-one starters > **TeSys 'Ultra'** Series
 - 0 to 80 A Motor Control/Protection/Monitoring system > **TeSys 'island'** Series.
- Other TeSys component names remain unchanged (TeSys F, TeSys B, TeSys T).

> TeSys K Series

The essential line for motors up to 7.5kW/16A direct on TeSys K series of Motor Starters



> TeSys Deca Series

The industrial standard for motors up to 75kW/150A direct on TeSys Deca series of Motor Starters



> TeSys Giga Series

For large motors up to 450kW/800A direct on TeSys Giga Series



> TeSys Ultra Series

The most compact totally coordinated solution for Motor Starters. For Direct On Line or Reversing Motor Control and Drive Protection upto 18.5kW/38 A on TeSys Ultra series



> TeSys Island Series

Digitally powered monitoring, control and protection of electrical motors up to 37kW/80 A on TeSys Island Series



TeSys Control

TeSys K

Control Relays - K Model (AC & DC Control)



- Conformance IEC, UL, CSA, CE Marking
- Inbuilt 4 auxiliary contacts
- 10A thermal rating
- Available with AC (50/60Hz Dual frequency), DC & DC low consumption coil options

No of Poles	AC Control Reference	Unit MRP [₹]				DC Control Reference ⁽⁴⁾	Unit MRP [₹]		
		B7 (24V)	F7 (110V)	M7 (220V)	N7 (415V)		BD (24V)	FD (110V)	MD (220V)
2NO + 2NC	CA2KN22*	1770	1770	1770	1770	CA3KN22**	2440	2440	2440
3NO + 1NC	CA2KN31*	1770	1770	1770	-	CA3KN31**	2440	2440	2440
4NO	CA2KN40*	1770	1770	1770	2115				

No of Poles	DC low consumption Reference ^{(1) (2) (3)}	Unit MRP [₹]		
		BW3 (24V)	EW3 (48V)	SW3 (72V)
2NO + 2NC	CA4KN22***	3020	3625	3020
3NO + 1NC	CA4KN31***	3020	3625	-
4NO	CA4KN40***	3020	-	-

For other coil voltage ratings regarding above, please contact Schneider Electric customer care.

* Reference to be completed by adding coil voltage code

(1) Compatible with PLC outputs

(2) Wide range coil (0.7...1.25Uc), suppressor fitted as standard

(3) 2 pole auxiliary contact block can be mounted additionally

(4) Optional in-built surge suppressor available

Power Contactors - K Model (3 Pole AC & DC Control)



- Conformance to IEC, UL, CSA
- Current Rating : 6A to 16A, AC-3 duty
- 1NO or 1NC inbuilt auxiliary contact
- Available in 3P & 4P version
- Available with AC (50/60Hz Dual frequency), DC & DC low consumption⁽⁵⁾ coil options

Motor Power (kW)	Auxiliary Contacts	AC Control Reference	Unit MRP [₹]				DC Control Reference ⁽⁵⁾	Unit MRP [₹]		
			B7 (24V)	F7 (110V)	M7 (220V)	N7 (415V)		BD (24V)	FD (110V)	MD (220V)
3	1NC	LC1K0601*	1485	1485	1485	1805	LP1K0601**	2300	2780	2300
	1NO	LC1K0610*	1485	1485	1485	1485	LP1K0610**	2300	2780	2300
5.5	1NC	LC1K0901*	1555	1555	1555	1875	LP1K0901**	2500	2500	2500
	1NO	LC1K0910*	1555	1555	1555	1555	LP1K0910**	2500	2500	2500
7.5	1NC	LC1K1201*	1760	1760	1760	-	LP1K1201**	2900	2900	-
	1NO	LC1K1210*	1760	1760	1760	2120	LP1K1210**	2900	3510	-
10	1NC	LC1K1601*	2075	2075	2075	-	-	-	-	-
	1NO	LC1K1610*	2075	2075	2075	-	-	-	-	-

For other coil voltage ratings contactors, please contact Customer Care.

* Reference to be completed by adding coil voltage code

(5) For low consumption offer, please contact Customer Care

Reversing Contactors - K Model



- Conformance to IEC, UL, CSA, CE
- Current Rating : 6A to 16A, AC-3 duty
- 1NO or 1NC inbuilt auxiliary contact
- Available in 3P & 4P version
- Available with AC(50/60Hz Dual frequency), DC & DC low consumption⁽⁶⁾ coil options

Motor Power (kW)	Auxiliary Contacts	AC Control Reference	Unit MRP [₹]	
			F7 (110V)	M7 (220V)
3	1 NC	LC2K0601*	4945	4945
	1 NO	LC2K0610*	4945	4945
5.5	1 NC	LC2K0901*	5280	5280
	1 NO	LC2K0910*	5280	5280
7.5	1 NC	LC2K1201*	5440	5440
	1 NO	LC2K1210*	5440	5440
10	1 NC	LC2K1601*	7310	-
	1 NO	LC2K1610*	6075	7310

For other coil voltage ratings contactors, please contact Customer Care.

* Reference to be completed by adding coil voltage code

(6) For current rating and ref please contact Customer Care

For details on non standard references, technical parameters, accessories, compatibility, stockable and non stockable status please contact Customer Care

NORMAL STOCK ITEMS

W.E.F. January 17th, 2024

TeSys Control

TeSys K

Accessories - K Model

Description	Mounting	Contacts	Reference	Unit MRP [₹]
Auxiliary contact block	Front	2NC	LA1KN02	805
	Front	1NO + 1NC	LA1KN11 <input checked="" type="checkbox"/>	735
	Front	2NO	LA1KN20	805
	Front	4NC	LA1KN04	1240
	Front	1NO + 3NC	LA1KN13	1240
	Front	2NO + 2NC	LA1KN22 <input checked="" type="checkbox"/>	1240
	Front	3NO + 1NC	LA1KN31	1240
	Front	4NO	LA1KN40	1240

Description	Control Voltage	Range	Reference	Unit MRP [₹]
On Delay Electronic Timer	24..48V AC/DC	1..30S	LA2KT2E ⁽¹⁾	4055

Description	Coil Voltage	Reference	Unit MRP [₹]
Surge Suppressor - RC Circuit	220..250V AC	LA4KA1U*	1265
Surge Suppressor - Varistor	130..250V AC/DC	LA4KE1UG*	1265
Surge Suppressor - Varistor	50..129V AC/DC	LA4KE1FC*	1265

* Lot size 5

(1) Front mounted with common point changeover contact

For details on non standard references, technical parameters, accessories, compatibility, stockable and non stockable status please contact Customer Care

NORMAL STOCK ITEMS

W.E.F. January 17th, 2024

TeSys Capacitor Duty Contactor

Capacitor Duty Contactor



Nominal Reactive Power 440V	Auxiliary Contacts	Reference	Unit MRP [₹]	
			F7 (110 V)	M7 (220V)
LC1-D•K - with Damping Resistors & Block of Early Make poles				
12.5 kVar	1NO + 2NC	LC1DFK*	5550	5550
16.7 kVar	1NO + 2NC	LC1DGK*	7795	7795
20 kVar	1NO + 2NC	LC1DLK*	-	8755
25 kVar	1NO + 2NC	LC1DMK*	9605	9605
32 kVar	1 NO + 2NC	LC1DPK*	20925	20925
40 kVar	1NO + 2NC	LC1DTK*	28825	28825
60 kVar	1NO + 2NC	LC1DWK12*	32450	32450

For other coil voltage ratings contactors, please contact Customer Care.

* Reference to be completed by adding coil voltage code



Instruction Manual
Video for Capacitor
Duty Contactors



Guide for the Design
and Production of LV
Power Factor
Correction Cubicles

For complete information on selection of capacitor switching please refer to the TeSys catalogue

For details on non standard references, technical parameters, accessories, compatibility, stockable and non stockable status please contact Customer Care

NORMAL STOCK ITEMS

W.E.F. January 17th, 2024

TeSys Control

TeSys Deca

The next-generation TeSys Deca series motor starters offer a reliable and robust solution for a faster machine time-to-market. It has a new modern look & feel and is designed to meet the requirements of Electro domestic applications. Ease of operation and reliability is guaranteed with the new multi-standard screws. Digital customer experience is enhanced with a QR embedded from product to packaging.

TeSys Deca Control Contactors (AC & DC Control)



- Conformance to IEC, UL, CSA
- 5 inbuilt auxiliary contacts, in just 2 variants
- Available with AC (50/60Hz Dual frequency), DC & DC low consumption coil options
- High Operating ambient temperature upto 60 Deg C
- Inbuilt surge suppressor for DC & DC low consumption

No of Poles	AC Control Reference	Unit MRP [₹]				DC Control Reference ⁽⁴⁾	Unit MRP [₹]		
		B7 (24V)	F7 (110V)	M7 (220V)	N7 (415V)		BD (24V)	FD (110V)	MD (220V)
3NO + 2NC	CAD32*	1910	1910	1910	1910	CAD32**	2745	2745	2745
5NO	CAD50*	1910	1910	1910	-	CAD50**	2745	2745	2745

No of Poles	DC low consumption Reference ^{(1) (2) (3)}	Unit MRP [₹]	
		BL (24V)	ML (220V)
3NO + 2NC	CAD32***	3435	5820
5NO	CAD50***	3435	-

For other coil voltage ratings contactors, please contact Customer Care.

* Reference to be completed by adding coil voltage code

(1) Compatible with PLC outputs

(2) Wide range coil (0.7...1.25Uc), suppressor fitted as standard

(3) 2 pole auxiliary block can be mounted

Power Contactors - Deca Model (3 Pole AC & DC Control)



- Conformance to IEC, UL, CSA
- Available with AC (50/60Hz Dual frequency), DC & DC low consumption coil options
- High Operating ambient temperature, no derating upto 60 Deg C
- Inbuilt 1NO + 1NC auxiliary contacts upto 150A
- High electrical and mechanical life
- Fuse-less Type 2 Co-ordination Charts available
- EverLink® terminal for 40, 50, 65 & 80A contactors
- Inbuilt surge suppressor in DC coil for 9-80A

[le] Rated Operational Current AC-1	kW	AC-3 Duty			Auxiliary Contacts	AC Control Reference	Unit MRP [₹]		
		HP	A				M7 (220V)	N7 (415V)	F7 (110V)
25	4	5.5	9	1 NO + 1 NC	LC1D09*	1915	1915	1915	
25	5.5	7.5	12	1 NO + 1 NC	LC1D12*	2155	2155	2155	
32	9	12.5	18	1 NO + 1 NC	LC1D18*	2500	2500	2500	
40	11	15	25	1 NO + 1 NC	LC1D25*	3095	3095	3095	
50	15	20	32	1 NO + 1 NC	LC1D32*	6015	6015	6015	
50	18.5	25	38	1 NO + 1 NC	LC1D38*	8675	8675	8675	
60	22	30	40	1 NO + 1 NC	LC1D40A*	9105	9105	9105	
80	25	35	50	1 NO + 1 NC	LC1D50A*	11865	11865	11865	
80	37	50	65	1 NO + 1 NC	LC1D65A*	16460	16460	16460	
125	45	60	80	1 NO + 1 NC	LC1D80*	24895	24895	24895	
125	45	60	95	1 NO + 1 NC	LC1D95*	26495	26495	26495	
250	59	80	115	1 NO + 1 NC	LC1D115*	32605	32605	32605	
250	80	110	150	1 NO + 1 NC	LC1D150*	40760	40760	40760	

For other coil voltage ratings contactors, please contact Customer Care.

* Reference to be completed by adding coil voltage code

For details on non standard references, technical parameters, accessories, compatibility, stockable and non stockable status please contact Customer Care

☑ NORMAL STOCK ITEMS

W.E.F. January 17th, 2024

TeSys Control

TeSys Deca

[le] Rated Operational Current AC-1	AC-3 Duty			Auxiliary Contacts	DC Control Reference ⁽¹⁾	Unit MRP [₹]		
	kW	HP	A			BD (24V)	FD (110V)	MD (220V)
25	4	5.5	9	1 NO + 1 NC	LC1D09*	3025	3025	3025
25	5.5	7.5	12	1 NO + 1 NC	LC1D12*	3400	3400	3400
32	9	12.5	18	1 NO + 1 NC	LC1D18*	4190	4190	4190
40	11	15	25	1 NO + 1 NC	LC1D25*	5295	5295	5295
50	15	20	32	1 NO + 1 NC	LC1D32*	10800	10800	10800
50	18.5	25	38	1 NO + 1 NC	LC1D38*	12760	12760	12760
60	22	30	40	1 NO + 1 NC	LC1D40A*	15285	15285	15285
80	25	35	50	1 NO + 1 NC	LC1D50A*	19180	19180	19180
80	37	50	65	1 NO + 1 NC	LC1D65A*	21750	21750	21750
125	45	60	80	1 NO + 1 NC	LC1D80*	29540	29540	29540
125	45	60	95	1 NO + 1 NC	LC1D95*	32375	32375	32375
250	59	80	115	1 NO + 1 NC	LC1D115*	38260	38260	38260
250	80	110	150	1 NO + 1 NC	LC1D150*	45915	45915	45915

For other coil voltage ratings contactors, please contact Customer Care.
* Reference to be completed by adding coil voltage code

TeSys Deca Power Contactors (3 Pole DC Low Consumption)

Now available upto 80A with the TeSys Deca Green Low Consumption offer

[le] Rated Operational Current AC1	Motor Power (Long Life) AC3			Auxiliary Contacts	Reference	Unit MRP [₹]	
	kW	HP	A			BL (24V)	EL (48V)
25	4	5.5	9	1 NO + 1 NC	LC1D09****	3320	3320
25	5.5	7.5	12	1 NO + 1 NC	LC1D12****	3715	3715
32	9	12.5	18	1 NO + 1 NC	LC1D18****	5675	5675
40	11	15	25	1 NO + 1 NC	LC1D25****	6915	6915
50	15	20	32	1 NO + 1 NC	LC1D32****	11825	11825

[le] Rated Operational Current AC1	Motor Power (Long Life) AC3			Auxiliary Contacts	Reference	Unit MRP [₹]			
	kW	HP	A			BBE (24V DC)	BNE (24-60V AC/DC)	EHE (48-130V AC/DC)	KUE (100-250V AC/DC)
60	22	30	40	1 NO + 1 NC	LC1D40A#	15285	15285	15285	15285
80	25	35	50	1 NO + 1 NC	LC1D50A#	19180	19180	19180	19180
80	37	50	65	1 NO + 1 NC	LC1D65A#	21750	21750	21750	21750
80	37	50	80	1 NO + 1 NC	LC1D80A#	26400	26400	26400	26400

For other coil voltage ratings contactors, please contact Customer Care.
* Reference to be completed by adding coil voltage code

TeSys Deca Power Contactors (4 Pole AC & DC Control)



- Conformance to IEC, UL, CSA
- Available with AC (50/60Hz Dual frequency), DC & DC low consumption⁽¹⁾ coil options
- High Operating ambient temperature, no derating upto 60 deg C

[le] Rated Operational Current AC1	Poles Composition	AC control Reference	Unit MRP [₹] M7 (220V)	DC control Reference	Unit MRP [₹]		
					BD (24V)	FD (110V)	MD (220V)
20	4NO	-	-	LC1DT20**	3655	3655	3655
	2NO+2NC	-	-	LC1D098**	3980	3980	3980
25	4NO	-	-	LC1DT25**	4390	4390	4390
	2NO+2NC	-	-	LC1D128**	5730	5730	5730
32	4NO	-	-	LC1DT32**	4825	8185	5780
	2NO+2NC	-	-	LC1D188**	6525	7810	6525
40	4NO	-	-	LC1DT40**	7565	7565	7565
	2NO+2NC	-	-	LC1D258**	9970	9970	9970
60	4NO	-	-	LC1DT60A#	15135	18135	18135
	2NO+2NC	-	-	LP1D40008**	19890	23835	19890
80	4NO	-	-	LC1DT80A#	22580	22580	-
	2NO+2NC	-	-	LP1D65008**	26740	26740	-
125	4NO	-	-	LP1D80004**	28965	34705	-
	2NO+2NC	-	-	LP1D80008**	33420	40040	33420
250	4NO	LC1D1150046*	36505	LC1D1150046**	40555	40555	-

Note: Please contact Customer Care for 4 Pole AC coil contactor details

⁽¹⁾ For current rating and ref please contact Customer Care

For other coil voltage ratings contactors, please contact Customer Care.

* Reference to be completed by adding coil voltage code

For details on non standard references, technical parameters, accessories, compatibility, stockable and non stockable status please contact Customer Care

✓ NORMAL STOCK ITEMS

W.E.F. January 17th, 2024



TeSys Deca Green

The Revolutionary Electronic Coil Contactor



Complete range in 3 frame sizes:

09-12-18A

25-32-38A

40-50-65-80A



Up to 80% less energy consumption than a traditional electromechanical motor starter

10X Reduction
in references

Only 3 references to cover the complete voltage range for AC and DC



Highest currents in smallest size, e.g.

PLC Compatible

Direct connection to a PLC without the need for an interposing relay

SEMIF47

High uptime thanks to wide band coil with high resistance to voltage surges/SEMIF47 conform



Scan to see TeSys Deca Green under voltage performance.

TeSys Control

TeSys Deca

TeSys Deca Green Contactor (3 Pole AC/DC Universal Coil)



- Universal AC/DC coil from 24 - 250V
- Special low consumption offer from 40-80A
- Fuseless Type 2 Co-ordination charts available

The Revolutionary Electronic Coil Contactor

[le] Rated Operational Current AC1	AC3 Duty (Long Life)			Auxiliary Contacts	Reference	Unit MRP [₹]		
	kW	HP	A			BNE (24-60V AC/DC)	EHE (48-130V AC/DC)	KUE (100-250V AC/DC)
25	4	5.5	9	1NO + 1NC	LC1D09*	3940	3940	3940
25	5.5	7.5	12	1NO + 1NC	LC1D12*	4085	4085	4085
32	9	12.5	18	1NO + 1NC	LC1D18*	5390	5390	5390
40	11	15	25	1NO + 1NC	LC1D25*	6435	6435	6435
50	15	20	32	1NO + 1NC	LC1D32*	13075	13075	13075
50	18.5	25	38	1NO + 1NC	LC1D38*	14110	16760	14110
60	22	30	40	1NO + 1NC	LC1D40A*	15285	15285	15285
80	25	35	50	1NO + 1NC	LC1D50A*	19180	19180	19180
80	37	50	65	1NO + 1NC	LC1D65A*	21750	21750	21750

For other coil voltage ratings contactors, please contact Customer Care.

* Reference to be completed by adding coil voltage code

TeSys Deca Green Power Contactors (4 Pole AC & DC Control)

[le] Rated Operational Current AC-1	Poles Composition	Auxiliary Contacts	DC Control Reference	Unit MRP [₹]			
				BBE (24V DC only)	BNE (24-60V AC/DC)	EHE (48-130V AC/DC)	KUE (100-250V AC/DC)
60	4NO	1NO + 1NC	LC1DT60A*	15135	15135	15135	15135
80	4NO	1NO + 1NC	LC1DT80A*	22580	22580	22580	22580

Coil Voltage Code

Type	Voltage	24-60V AC/DC	48-130V AC/DC	100-250V AC/DC
AC/DC*	LC1D09 - D38, LC1D40A - 80A, LC1DT60A - 80A	BNE	EHE	KUE
24V DC Low Consumption*	LC1D40A - 80A, LC1DT60A - 80A	BBE (24V DC only)	-	-

For other coil voltage ratings contactors, please contact Customer Care.

* Reference to be completed by adding coil voltage code



Check the features of the TeSys Deca Green

For details on non standard references, technical parameters, accessories, compatibility, stockable and non stockable status please contact Customer Care

NORMAL STOCK ITEMS

W.E.F. January 17th, 2024

TeSys Control

TeSys Deca

Description	For use with	Reference	Unit MRP [₹]
Power connection accessories			
Terminal block	For supply to one or more GV2 G busbar sets	GV1G09	2370
Set of 63A busbars for parallelling of contactors	2 contactors LC1D09...D18 or D25...D38	GV2G245	2300
	4 contactors LC1D09...D18 or D25...D38	GV2G445	3620
Set of 115A busbars for parallelling of contactors	2 contactors LC1D40A...D80A	GV3G264	4135
	3 contactors LC1D40A...D80A	GV3G364 ⁽¹⁾	2210
Set of S-shape busbars	For circuit breakers GV3P** & GV3L** and contactors LC1 D40A...D65A	GV3S	1655

**Not applicable for GV3P/GV3L 73A and 80A



GV2G245



GV1G09

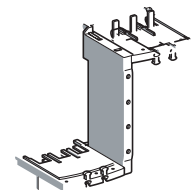

GV3S

Description	For use with	Reference	Unit MRP [₹]
Mechanical interlock	LC1D09 to D38(1)	LAD9V2	845
	LC1D40A to D65A(1)	LAD4CM	1715
	LC1D80 and D95 (for AC control voltage)	LA9D4002	3760
	LC1D80 and D95 (for DC control voltage)(2)	LA9D8002	5595
	LC1D115 and D150(2)	LA9D11502	5675

(1) With this set of busbars, any one contactor can be supplied directly by its EverLink® double cage power terminal block. The other two contactors are supplied by the busbar set. The 115A limitation is therefore applied to these two contactors.

(2) With electrical interlock

Description	For use with	Reference	Unit MRP [₹]
Power Connection for Reversing			
Kit Comprising :	LC1D09 to D38	LAD9V5	700
1. A set of parallel bars	LC1D09 to D38	LAD9V6	875
2. A set of reverser bars.	LC1D40A to D80A	LA9D65A69	3650
	LC1D80 and D95 (for AC control voltage)	LA9D8069	7810
	LC1D80 and D95 (for DC control voltage)	LA9D8069	7810
	LC1D115 and D150	LA9D11569	12995

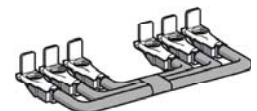
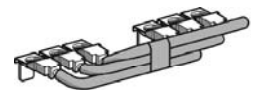

LA9 D8069

Description	For use with	Reference	Unit MRP [₹]
Reversing Kit			
Kit Comprising :			
1. A mechanical interlock LAD 9V2 with electrical interlocking LAD 9V1	LC1D09 to D38	LAD9R1V	1755
2. A set of power connections LAD 9V5 (parallel) and LAD 9V6 (reversing).			
Kit Comprising :			
1. A mechanical interlock LAD 9V2 without electrical interlocking	LC1D09 to D38	LAD9R1	1745
2. A set of power connections LAD 9V5 (parallel) and LAD 9V6 (reversing).			
Kit Comprising :			
1. A mechanical interlock LAD 4CM	LC1D40A to D80A	LAD9R3	4165
2. A set of power connections LA9 D65A69.			

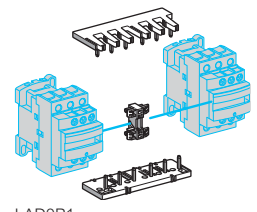

LAD9R1

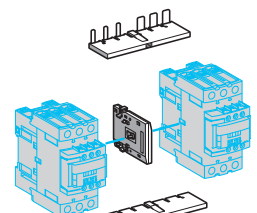

LAD9R3

Description	For use with	Reference	Unit MRP [₹]
Star Delta Kit			
Time delay contact block LAD S2 (LC1D09...D80),	LC1D09 and D12	LAD91217	6590
Power circuit connections (LC1D09...D80),	LC1D18 to D32	LAD93217	8475
Hardware required for fixing the contactors onto the mounting plate (LC1D80)	LC1D40A and D50A	LAD9SD3	17125
	LC1D80	LA9D8017	19015



LAD91217



LAD9SD3



LA9D8017

For details on non standard references, technical parameters, accessories, compatibility, stockable and non stockable status please contact Customer Care

✓ NORMAL STOCK ITEMS

W.E.F. January 17th, 2024

TeSys Control

TeSys Deca

Description	Time Delay Range	Timer Type	Reference	Unit MRP [₹]
On delay timer ^{(1) (2)}	15...30 s	on delay	LA4DT2U	6340
On delay timer ^{(1) (2)}	0.1...2 s	on delay	LA4DT0U	6340
On delay timer ^{(1) (2)}	25...500 s	on delay	LA4DT4U	5840
Relay interface module - 24V DC ^{(1) (2)}	-	-	LA4DFB	7105

(1) For LC1 D09...38A (3P, AC coils only) add mounting adaptor LAD4BB and for LC1 D40A...65A (3P, AC coils only), add mounting adaptor LAD4BB3.

(2) For LC1D80...150 (3P), direct mounting, for 100-250V AC Coils only.

Description	For use with	Reference	Unit MRP [₹]				
			B (24V) (AC/DC)	E (42/48V) (AC/DC)	F (110/127V) (AC/DC)	M (220/240V) (AC/DC)	Q (380/415V) (AC/DC)
TeSys Deca Model Mechanical Latch Blocks							
Front, Clip-on	LC1D09...D38 (a or c) LC1DT20...DT40 (a or c) LC1D40A...D65A (3P a or c) LC1DT60A and DT80A (4P a or c)	LAD6K10*	7620	7620	7620	7620	7620
	LC1D80...D150 (3P a) LC1D80 and D115 (3 P c) LC1D80 (4 P a) LC1D80 and D115 (4 P a) LP1D80 and LC1D115 (4 P c)	LA6DK20*	7955	8920	8920	7955	12535

* Reference to be completed by adding coil voltage code and recommended to check availability with Customer Care team

Spare Coils TeSys Deca Model

Product Compatibility	Reference
AC Coils	
CAD, LC1-D09...D38, DT20..40	LXD1*
LC1D40A, D50A, D65A & LC1DT60A, DT80A	LXD3*
D80 & D95 (3P & 4P)	LX1D6*
LC1-D115, D150	LX1D8*
DC Coils	
LC1-D80-D95	LX4D7**
LC1-D115, D150	LX4D8**

* Reference to be completed by adding coil voltage code and recommended to check availability with Customer Care team

Coil Voltage Code

Type	Voltage (V)	24	110	220	415
AC*	CAD, LC1-D09...D38, DT20..40, LC1 - D150, LC1D40A, D50A, D65A & LC1DT60A, DT80A, LC1D150 LC1D80, D95, D115	B7	F7	M7	N7

For details on non standard references, technical parameters, accessories, compatibility, stockable and non stockable status please contact Customer Care

NORMAL STOCK ITEMS

W.E.F. January 17th, 2024

Accessories

Description	For use With	Contacts	Reference	Unit MRP [₹]	
Add On Blocks					
Additional instantaneous auxiliary contact blocks	LC1D09 ...LC1D150*	Front Mounted 1NO + 1NC	LADN11	565	
		Front Mounted 2NO	LADN20 ✓	565	
		Front Mounted 2NC	LADN02	900	
		Front Mounted 2NO + 2NC	LADN22 ✓	1025	
		Front Mounted 4NC	LADN04	1490	
		Front Mounted 4NO	LADN40 ✓	1025	
		Front Mounted 1NO + 3NC	LADN13	1025	
		Front Mounted 3NO + 1NC	LADN31 ✓	1025	
		LC1D80..LC1D95	Front Mounted 1NO	LADN10	500
			Front Mounted 1NC	LADN01	500

Description	Contacts	Reference	Unit MRP [₹]
Add On Blocks			
Additional instantaneous auxiliary contact blocks	Side Mounted ⁽¹⁾ 1NO + 1NC	LAD8N11	2145
	Side Mounted ⁽¹⁾ 2NO	LAD8N20	2145
Pneumatic timer blocks front mounted	ON delay 1NO + 1NC 0.1..3s	LADT0	4075
	ON delay 1NO + 1NC 0.1..30s	LADT2	4075
	ON delay 1NO + 1NC 10..180s	LADT4	4075
	ON delay 1NO + 1NC 1..30s (2)	LADS2 ✓	4350
	OFF delay 1NO + 1NC 0.1 ..3s	LADR0	4075
	OFF delay 1NO + 1NC 0.1 ..30s	LADR2 ✓	4075
	OFF delay 1NO + 1NC 10..180s	LADR4	4075

(1) Suitable for mounting on TeSys Deca range AC Coil Contactors and Control Relays only

(2) With Switching time of 40 ms between opening of the NC contact and closing of the NO contact recommended for Star - Delta Starters

Accessories compatibility

Contactors		Instantaneous Auxiliary Contacts			Time delay Front Mounted		
Type	Number of Poles and Size	Side mounted	Front mounted	1 contact	2 contact	4 contacts	
AC & AC/DC	3P LC1D09...D38	1 on LH side	and	-	1	or 1	or 1
AC & AC/DC	3P LC1D40A...D80A	1 on LH or 1 on RH side	and	-	1	or 1	or 1
AC & AC/DC	3P LC1D80 and D95A (50/60 Hz)	1 on each side	or	2	and 1	or 1	or 1
AC & AC/DC	3P LC1D80 and D95A (50 or 60 Hz)	1 on each side	and	2	and 2	or 1	or 1
AC & AC/DC	3P LC1D115 and D150	1 on LH side	and	-	1	or 1	or 1
AC & AC/DC	4P LC1DT20...DT40	1 on LH side	and	-	1	or 1	or 1
AC & AC/DC	4P LC1DT60A and DT80A	1 on LH or 1 on RH side	and	-	1	or 1	or 1
AC & AC/DC	4P LC1D40008, D65008 and D80	1 on each side	or	1	or 1	or 1	or 1
AC & AC/DC	4P LC1D115	1 on each side	and	1	or 1	or 1	or 1
DC	3P LC1D09...D38	-		-	1	or 1	or 1
DC	3P LC1D40A...D80A	-		-	1	or 1	or 1
DC	3P LC1D80 and D95	-		1	or 1	or 1	or 1
DC	3P LC1D115 and D150	1 on LH side	and	-	1	or 1	or 1
DC	4P LC1DT20...DT40	-		-	1	or 1	or 1
DC	4P LC1DT60A and DT80A	-		-	1	or 1	or 1
DC	4P LC1D40008, D65008 and D80	-		2	and 1	or 1	or 1
DC	4P LC1D115	1 on each side		-	and 1	or 1	or 1
LC ⁽³⁾	3P LC1D09...D38	-		-	1	-	-
LC ⁽³⁾	3P LC1DT20...DT40	-		-	1	-	-

(3) LC : Low consumption

TeSys Control

TeSys Deca

Accessories

Description	For use with	Reference	Unit MRP [₹]
For Contactor D115/150			
Contacts set - 3P	LC1D115	LA5D1158031	24960
Contacts set - 3P	LC1D150	LA5D150803	25875
Contacts set - 4P	LC1D1150046	LA5D115804	34405

Product Compatibility	Fixing	Control Circuit Voltage	Suppressor Type	Reference	Unit MRP [₹]
Coil Suppressor Modules					
LC1D12...D25 (4P)	Screw	110...240V AC	RC Circuit AC	LA4DA1U	1955
	Screw	12...250V DC	Diode DC	LA4DC1U	2190
LC1D09...D38, LC2D09...D38, LC1DT20...DT40, LC2DT20...DT40 (3P)	Screw	24...48V AC	Varistor AC/DC	LAD4VE	1895
	Screw	24...48V AC 400Hz	RC Circuit AC	LAD4RCE	1895
	Screw	50...127V AC 200Hz	RC Circuit AC	LAD4ROG	1715
	Screw	110...240V AC 100Hz	RC Circuit AC	LAD4RCU <input checked="" type="checkbox"/>	1895
CAD	Screw	110...250V AC	Varistor AC/DC	LAD4VU	1895
	Screw	24...250V DC	Diode DC	LA4DC3U	1955
LC1D80, LC1D95, LC2D80, LC2D95 (3P) LC2D80 (4P), LC1D40008, LC1D65008	Screw	110...250V AC	Varistor AC/DC	LA4DE2U	1870
	Screw	24...48V AC 400Hz	RC Circuit AC	LA4DA2E	1870
	Screw	50...127V AC 200Hz	RC Circuit AC	LA4DA2G	2950
	Screw	110...240V AC 100Hz	RC Circuit AC	LA4DA2U	1955
	Screw	380...415V AC 150Hz	RC Circuit AC	LA4DA2N	2950
	Screw	24...48V DC	Varistor AC/DC	LA4DE3E	1955

For details on non standard references, technical parameters, accessories, compatibility, stockable and non stockable status please contact Customer Care

NORMAL STOCK ITEMS

W.E.F. January 17th, 2024

TeSys Control

TeSys Deca

Modular marking system simplifies identification of standard contactors in the control panel to enhance visibility of the safety chain

Simple, customisable modular marking system

Standard TeSys Deca contactors

Easy-to-attach covers:



Auxiliary blocks with safety chain identification also available for more contact points:

Standard TeSys Ultra motor starters

Translucent labels to identify safety-chain devices:



Flexibility to customise contactors included in the safety chain during panel building



Simpler and faster maintenance with 100% visibility



Safety covers and auxiliary blocks prevent screwdriver contact with poles

Complete safety-chain identification system

TeSys Deca range

Retrofit contactor safety covers



LAD9ET1S
9A upto 65A



LAD9ET3S
80A to 95A



LAD9ET4S
110A to 150A



LADN22S
2NO + 2NC

Also available for CAD32/CAD50

TeSys Ultra range

Retrofit identification label



LU9ET1S

Built in Safety

TeSys Ultra motor starters are certified according to IEC 60947-4-1 for safety applications thanks to integrated mirror contact

Description	For use with	Reference	Unit MRP [₹]
Red Cover (For safety chain indication)	LC1D09...D65A and DT20 .. DT80A	LAD9ET1S	810
Auxiliary Contact block with red front face- for safety chain indication	2NO + 2NC	LADN22S	1155

For details on non standard references, technical parameters, accessories, compatibility, stockable and non stockable status please contact Customer Care

✓ NORMAL STOCK ITEMS

W.E.F. January 17th, 2024



TeSys Giga - Future Ready

A New Generation Series with Digital Innovation

TeSys Giga is new range of high-power contactors that supports industry requirements with process performance monitoring through data networks and online expert services.

Optimized Predictive Maintenance through-

- Continuous local and remote monitoring of contact wear
- Replaceable contacts (when necessary), facilitated by diagnostic visual indicator.

Unique Design-

- Innovative design and feature with compact size
- Ergonomic design & Flexibility in connections.
- Embedded auxiliary contact blocks
- Wideband electronic coils



TeSys Control

TeSys Giga

TeSys Giga High Power Contactors

Both "Standard" & "Advanced" versions available in 3 sizes, covering several ratings



Standard Version

Power & control

- 3 or 4 power poles
- 115 to 800A (AC-3)
- 200 to 1050A (AC-1)
- Embedded 1 NO + 1 NC auxiliary contacts
- Push-in type terminals for coils & control

Remote control

- 48-130V, 100-250V AC/DC coils
- Wide voltage range coils (direct coil control)
- Embedded surge-suppressor

Diagnostic

- Embedded wear diagnostic
- Embedded control voltages diagnostic
- Self diagnosis function
- Local alarm signaling (LED)



Advanced Version

Advanced diagnostic features along with standard version -

Diagnostic

- Remote wear diagnostic signaling kit (accessory)

Mounting

- Cable memory' adapter enables maintenance without removing power cables and busbar connections.

Remote control

- 24-48 V, 200-500 V AC/DC coils
- Digital control input (PLC output digital coil control)

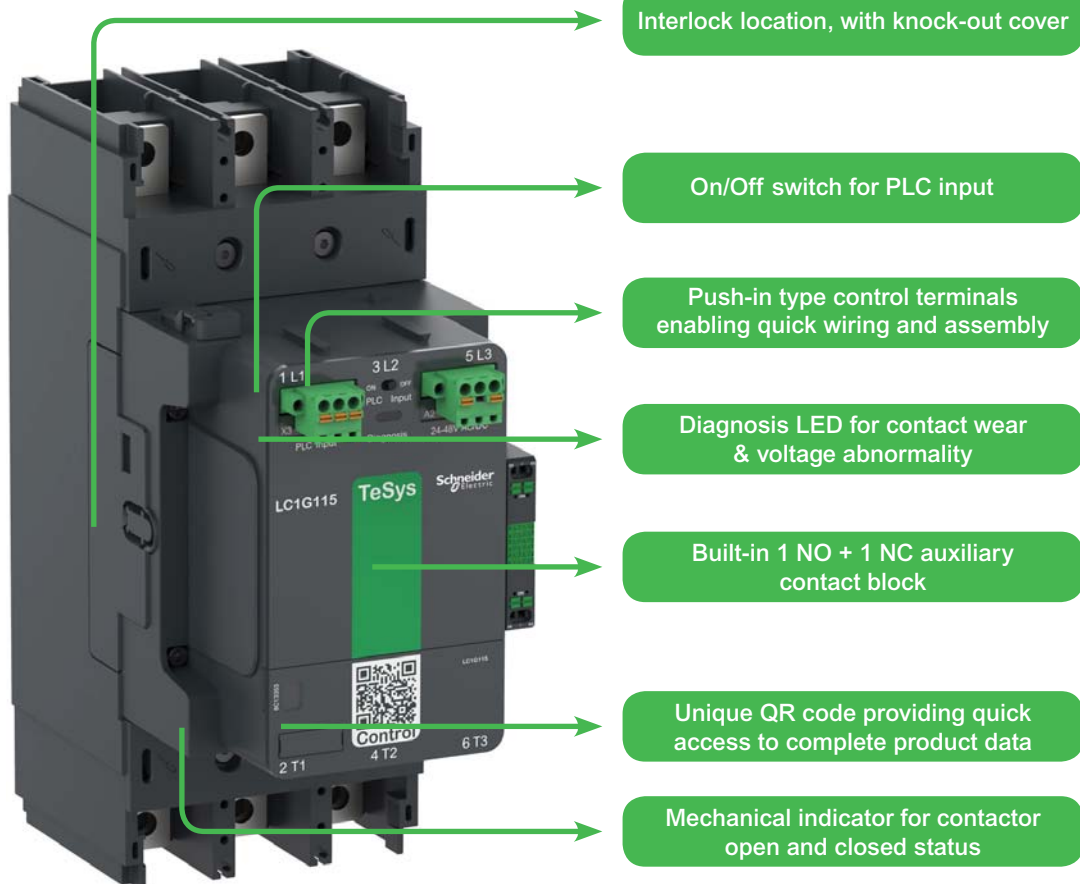

TeSys Control

TeSys Giga

Quick & Easy Replacement of TeSys F with TeSys Giga Contactors with Retrofit Bases



Description	Reference	Unit MRP [₹]
Substitutes LC1F115-225 with LC1G115-225	LA9GRFB1	On Request
Substitutes LC1F265-500 with LC1G265-500	LA9GRFB2	On Request
Substitutes LC1F630-800 with LC1G630-800	LA9GRFB3	On Request



- Suitable for 3 pole contactors
- The bases come in two frame sizes.
- Upgrade your system with the new range of contactors in just 3 simple steps:

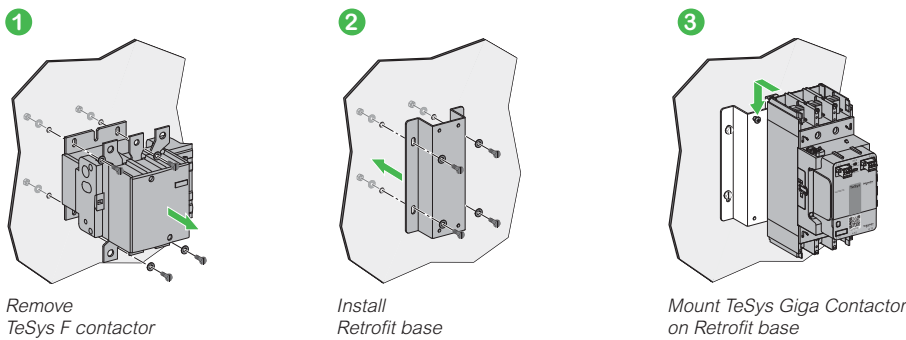

TeSys Giga Power Contactors (3 Pole AC/DC)

[Ie] Rated Operational Current AC-1	Motor Power (Long Life) AC-3		Standard version Reference	Unit MRP [₹]	
	kW (@415V)	A		EHEN (48-130 V)	KUEN (100-250 V)
250	55	115	LC1G115****	30270	31310
275	75	150	LC1G150****	39925	39925
305	90	185	LC1G185****	49480	49480
330	110	225	LC1G225****	53245	53245
385	132	265	LC1G265****	65445	65445
440	160	330	LC1G330****	79140	79140
550	200	400	LC1G400****	95650	95650
700	250	500	LC1G500****	132690	132690
1050	375	630	LC1G630****	On Request	On Request
1050	450	800	LC1G800****	On Request	On Request

TeSys Giga Power Contactors (4 Pole AC/DC)

[Ie] Rated Operational Current AC-1	Power Pole Composition	Standard version Reference	Unit MRP [₹]	
			EHEN (48-130 V)	KUEN (100-250 V)
250	4 NO	LC1G1154****	49680	49680
275	4 NO	LC1G1504****	59110	59110
305	4 NO	LC1G1854****	73860	73860
330	4 NO	LC1G2254****	86760	86760
385	4 NO	LC1G2654****	97005	97005
440	4 NO	LC1G3304****	112890	112890
550	4 NO	LC1G4004****	140300	140300
700	4 NO	LC1G5004****	206755	206755
1050	4 NO	LC1G6304****	On Request	On Request
1050	4 NO	LC1G8004****	On Request	On Request

Note:

For ordering advanced version replace **N** with **A** in reference as EHEN/KUEN → EHEA/KUEA respectively.

Example: LC1G1154 EHEN → LC1G1154 EHEA.

For other coil voltage ratings contactors, please contact Customer Care.

* Reference to be completed by adding coil voltage code

For details on non standard references, technical parameters, accessories, compatibility, stockable and non stockable status please contact Customer Care

☑ NORMAL STOCK ITEMS

W.E.F. January 17th, 2024

TeSys Control

TeSys Giga

Giga High power contactors – Power wiring accessories

Product references

Power Terminals

Spreader Kits



Description	Suitable for	Compatible with Contactors	Increase of Pole Pitch	Quantity Set of	Reference	Unit MRP [₹]
Spreader kits	3P	LC1G115...LC1G225	35 to 45 mm	3	LA9G3611	On Request
	3P	LC1G265...LC1G500	45 to 70 mm	3	LA9G3612	On Request
	4P	LC1G115...LC1G225	35 to 45 mm	4	LA9G4611	On Request
	4P	LC1G265...LC1G500	45 to 70 mm	4	LA9G4612	On Request

Terminal extensions for larger power connections



Description	Suitable for	Compatible with Contactors	Power Connection Size	Quantity Set of	Reference	Unit MRP [₹]
Terminal connections	3P	LC1G400...LC1G500	50 mm width	3	LA9G3613	On Request
	3P	LC1G630...LC1G800	80 mm width	3	LA9G3614	On Request
	4P	LC1G400...LC1G500	50 mm width	4	LA9G4613	On Request
	4P	LC1G630...LC1G800	80 mm width	4	LA9G4614	On Request

Power Terminal Accessories

Phase Separators



Description	Suitable for	Compatible with Contactors	Quantity Set of	Reference	Unit MRP [₹]
Phase separators ⁽¹⁾	3P	LC1G115...LC1G800	2	LA9G3801	On Request
	4P	LC1G115...LC1G800	3	LA9G4801	On Request
	3P – with 50/80 mm spreaders	LC1G400...LC1G800	2	LA9G3803 ⁽²⁾	On Request
	4P – with 50/80 mm spreaders	LC1G400...LC1G800	3	LA9G4803 ⁽³⁾	On Request

(1) Either phase separators or terminal shrouds can only be mounted. Phase separators or terminal shrouds are mandatory for operational voltage, $U_e \geq 690$ V.

(2) To be used with LA9G3613 and LA9G3614.

(3) To be used with LA9G4613 and LA9G4614.

For details on non standard references, technical parameters, accessories, compatibility, stockable and non stockable status please contact Customer Care

NORMAL STOCK ITEMS

W.E.F. January 17th, 2024

TeSys Control

TeSys Giga

Accessories

Description	Terminal Type	Position	Contacts	Reference	Unit MRP [₹]
Add On Blocks	Push In				
	1st left or 1st right	Side Mounted ⁽¹⁾	1 NO+1NC	LAG8N113P	1410
Auxiliary contact module	1st left or 1st right	Side Mounted	2 NO	LAG8N203P	1825
	2nd left or right	Side Mounted	1 NO+1NC	LAG8N113	1410
	2nd left or right	Side Mounted	2 NO	LAG8N203	1825

(1) Always supplied with TeSys Giga LC1G contactors, fitted to the right side lateral face.

Accessories

For Use With Contactor	Reference	Unit MRP [₹]
Mechanical interlock between contactors ⁽¹⁾		
Between Identical contactor frames	LA9G970	2570
Between LC1G(265-500) and LC1G(185-225)	LA9G971	2570
LC1G630 to LC1G800 and LC1G265 to LC1G500	LA9G972	On Request*

(1) Maximum 3 auxiliary contacts can be installed between 2 contactors with mechanical interlock kit.

Spare Control Module



- Wide band electronic control
- 24 V...500 V 50/60 Hz or DC control input
- Advanced and standard versions
- Accessible from the front for easy and quick replacement

Pole Composition	Control modules for Standard contactors	Reference	Unit MRP [₹]	
			EHEN (48-130V)	KUEN (100-250V)
3-Pole	LC1G115...LC1G225	LX1G3Q*	On Request	On Request
3-Pole	LC1G265...LC1G330	LX1G3R*	On Request	On Request
3-Pole	LC1G400...LC1G500	LX1G3S*	On Request	On Request
3-Pole	LC1G630...LC1G800	LX1G3T*	On Request	On Request
4-Pole	LC1G115...LC1G225	LX1G3Q*	On Request	On Request
4-Pole	LC1G265...LC1G330	LX1G3R*	On Request	On Request
4-Pole	LC1G400...LC1G500	LX1G3S*	On Request	On Request
4-Pole	LC1G630...LC1G800	LX1G3T*	On Request	On Request

For other coil voltage ratings regarding above, please contact Schneider Electric customer care.

* Reference to be completed by adding coil voltage code

For details on non standard references, technical parameters, accessories, compatibility, stockable and non stockable status please contact Customer Care

NORMAL STOCK ITEMS

W.E.F. January 17th, 2024

TeSys H – Hybrid Starter

Standard version

- **2 ratings:**
 - 2.4 A 400 V AC53a
 - 6.5 A 400 V AC53a
- **2 control voltages:**
 - 24 V DC
 - 110 V / 230 V AC
- **2 terminal types:**
 - Screw clamps
 - Spring
- **Can provide up to 3 functions:**
 - Forward running
 - Reverse running
 - Overload protection



Safety version

- **Safe Torque Off embedded:**
 - SIL3 according to IEC61508-1
 - Ple according to ISO13849-1
- **ATEX:**
 - As associated devices for motor protection



- **Get Up to 75 % of space reduction** with ultra-compact 22.5 mm starter that ensures maximum space savings for group starter architecture. (Reversing starter also available within the same width)
- **Long electrical durability** with 30 Million AC53a electrical cycles, suitable for high demanding application
- **Easy design** with both wide range of setting motor protection such as Automatic, manual or remote reset after thermal trip and wide range of control voltage
- **Integration made easy** with direct mounting installation on DIN rail or Control terminals on the upperside or Power terminal on the lower side

Understanding Hybrid Technology

Hybrid technology:

Each contact is coupled with a power semiconductor for switching

- > Higher number of on/off switches, extended durability.

> Closing

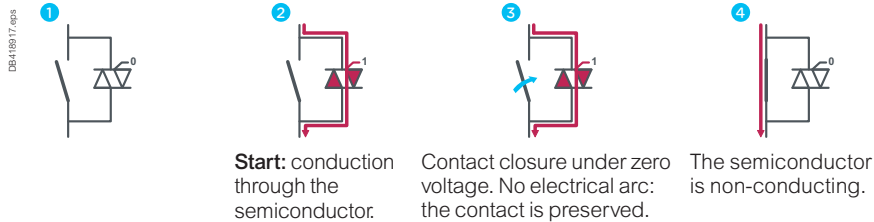

> Opening

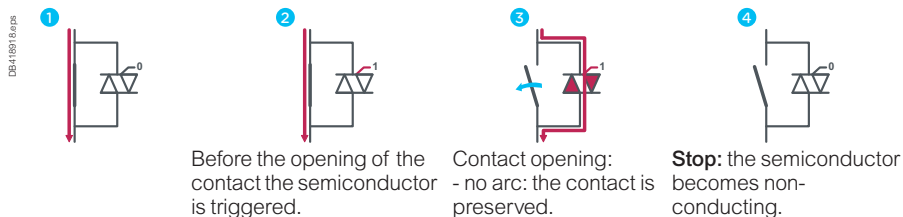

Starters for asynchronous motors - AC53a utilization category:

Starters	3 - Phases Motor: Max Power (KW) for Various Voltage							Current Range	Commercial References	Unit MRP [₹]	
	220 V	230 V	380 V	400 V	415 V	440 V	500 V			A	BD (24 V DC)
Direct-on-line											
Screw terminals	0.37	0.37	0.75	0.75	0.75	0.75	1.1	0.18...2.4	LZ1H2X4*	35210	-
	1.5	1.5	2.2	3	3	3	3	1.5...6.5	LZ1H6X5*	35620	-
Reverse											
Screw terminals	0.37	0.37	0.75	0.75	0.75	0.75	1.1	0.18...2.4	LZ2H2X4*	35890	43635
	1.5	1.5	2.2	3	3	3	3	1.5...6.5	LZ2H6X5*	37695	-

For other coil voltage ratings regarding above, please contact Schneider Electric customer care.

* Reference to be completed by adding coil voltage code

For details on non standard references, technical parameters, accessories, compatibility, stockable and non stockable status please contact Customer Care









✓ NORMAL STOCK ITEMS

W.E.F. January 17th, 2024

TeSys Protection Range

TeSys has the most rugged and reliable solution to manage motors

Please find a quick range overview below

	TeSys Power		TeSys Protect				TeSys Active		
Feature	Motor Protection Circuit Breakers		Overload Relays		Multi function Relays		TeSys Ultra	TeSys T	TeSys Island
TeSys Range of Products	GV2P, GV4P GV3P, GV2ME	GV4PEM	LR2K, LRD, LR9D, LR9F	LR9G	EOCR				
									
Short circuit									
Causes of overheating									
Slight overload									
Locked rotor									
Ventilation fault With probes							With Probes	With Probes	
Abnormal temperature rise								With Probes	
Shaft bearing seizure									
Insulation fault					With CBCT				
Long starting time Adjustable Adjustable		Adjustable			Adjustable	Adjustable	Adjustable	Adjustable	
Heavy duty			LR9D only						
Voltage variation (Derived)									
Causes of phase variation									
Phase reversal									
Phase losses									
Phase imbalance									
Earth fault	GV4P only								
Historic fault, Pre-Alarming					Possible Pre alarm				

Protection Relays for Motor Safety



Providing Motor Safety
tailored to your needs



TeSys Protect

TeSys K, TeSys Deca, TeSys F, TeSys Giga

Thermal Overload Relays - TeSys K Series (Direct Mounting)



- Conformance to IEC, UL, CSA, CE
- Range : 0.1A to 16A
- Direct & Independent mounting
- Trip class 10A

Thermal Protection Adjustment	For Use With	For Use With	Unit MRP [₹]
0.11...0.16		LR2K0301	2600
0.16...0.23		LR2K0302	2600
0.23...0.36		LR2K0303	2600
0.36...0.54		LR2K0304	2600
0.54...0.8		LR2K0305	2600
0.8...1.2		LR2K0306	2600
1.2...1.8	LC1K, LP1K, LP4K, LP2K, LC2K	LR2K0307	2600
1.8...2.6		LR2K0308	2600
2.6...3.7		LR2K0310	2600
3.7...5.5		LR2K0312	2600
5.5...8		LR2K0314	2600
8...11.5		LR2K0316	2600
10...14		LR2K0321	2685
12...16		LR2K0322	2685

*Note: Terminal Block for Clip-on Mounting LA7K0064

Thermal Overload Relays - TeSys Deca Series



- Conformance to IEC, UL, CSA
- Range : 0.1A to 104A
- Higher operating temperature
- Tripping class 10A & 20 available
- Direct mounting on contactor is possible upto 95A

Thermal Protection Adjustment Range	For Use With	Reference*	Unit MRP [₹]
LRD Model (Direct Mounting)			
0.1...0.16		LRD01	2615
0.16...0.25		LRD02	2615
0.25...0.4		LRD03	2615
0.4...0.63		LRD04	2615
0.63...1		LRD05 ✓	2615
1...1.6	GV2L03, LE03, LC1D09...LC1D38	LRD06 ✓	2615
1.6...2.5		LRD07 ✓	2615
2.5...4		LRD08 ✓	2615
4...6		LRD10 ✓	2615
5.5...8		LRD12 ✓	2615
7...10		LRD14 ✓	2930
9...13		LRD16 ✓	2930
12...18		LRD21 ✓	3020
16...24	GV2L22, LC1D25...D38	LRD22 ✓	3020
23...32	LC1D25...LC1D38, LC1D32	LRD32 ✓	4855
30...38	LC1D32, LC1D38	LRD35	4855
23...32	LC1D40A...D65a	LRD332	5375
23...32	LC1D80...LC1D95	LRD3353	5375
30...40	LC1D40A...D65a	LRD340	5375
30...40	LC1D80...LC1D95	LRD3355	5375
37...50	LC1D40A...D65a	LRD350 ✓	7370
37...50	LC1D80...LC1D95	LRD3357	8815
48...65	LC1D40A...D65a	LRD365	9460
62...80	LC1D80A	LRD380	9865
48...65	LC1D80...LC1D95	LRD3359	9460
63...80	LC1D80...LC1D95	LRD3363	10265
80...104	LC1D80, LC1D95	LRD3365	12670

Electronic Overload Relay - TeSys Deca Series



- Conformance to IEC, UL, CSA
- Range : 0.1A to 32A
- 5:1 Adjustment range
- High Operating Temperature
- Field selectable tripping class : 5,10, 20 & 30
- Type 1 & Type 2 Co-ordination chart available

Current Range	For Use With	Reference*	Unit MRP [₹]
0.1...0.5		LR9D01	11890
0.4...2.0	LC1D09 - 38A Direct Mounting	LR9D02	12205
1.6...8.0		LR9D08	12205
6.4...32		LR9D32	13655

*Note: For LR9D01 to LR9D32 - Terminal Block for Clip on Mounting LAD7B205.

Electronic Overload Relay - TeSys Giga Series



- Wide range of protection with only 4 references (28A to 630A)
- Switchable protection against ground fault and phase imbalance
- ON status and overload alarm signaling by LED
- Direct mounting of relay with contactors saving in panel space and installation time
- Selectable Trip class from 5E to class 30E to suit different application needs

Thermal Protection Adjustment Range	Reference	Unit MRP [₹]
28...115 A	LR9G115	20225
57...225 A	LR9G225	23595
125...500 A	LR9G500	27750
160...630 A	LR9G630*	on request

*Note:

- For LRD01...LRD35 - Terminal Block for clip-on Mounting LAD7B106
- For LRD33** - Terminal Block for clip-on Mounting LA7D3064 ✓
- For LRD332, LRD340, LRD350 & LRD365 - Connection block for separate mounting LAD96560
- The LRD relays can be used for AC or DC current up to 104A
- For long starting, Class 20 relays are available on request.
- Device for remote tripping and electrical reset is available on request.

For details on non standard references, technical parameters, accessories, compatibility, stockable and non stockable status please contact Customer Care

✓ NORMAL STOCK ITEMS

W.E.F. January 17th, 2024



- Reduced downtime
- Quick restoration
- Operational Safety
- Power Quality management



Electronic Overcurrent Relays

Digital EOCR

Protection

- Over Current-Definite & Inverse Time
- Under Current
- Phase Loss
- Phase Reversal
- Stall
- Jam
- Imbalance
- Earth Fault*

Diagnostic

- Trip Cause
- Fault History-3 Faults (Cause & Current Value)

Measurement

- Load Current
- Ground Current*
- Running Hours
- Load Current Bar Graph
- i-THD (Current Harmonic Distortion)

Other Features

- Modbus Communication*
- 4-20 mA output for Motor Current*
- Pre-Alarm Contact
- Suitable for 1 Φ & 3 Φ Motors
- Suitable for Low Frequency VFD Operation (10-100Hz)
- Available with Type-2

Analog EOCR

Protection

- Over current
- Phase loss
- Locked rotor

Other Features

- Easy installation, with DIN Rail and Panel Mounting compatibility
- Trip cause display
- Manual/Electrical reset
- Testing Provision through Test Button
- Suitable for 1 Φ & 3 Φ Motors

* In selected models

se.com/in

TeSys Protect

EOCR

Digital EOCR





Digital EOCR Without Communication						
Current Range=0.5A-80A						
Control Voltage=100VAC-220VAC*						
Description	Display	Bottom Hole		Window Hole		
		Reference	Unit MRP [₹]	Reference	Unit MRP [₹]	
Without Ground Fault Protection	Inbuilt	3DM2-WRDUHZ	21645	3DM2-WRDUWZ	21645	
	Extended**	FDM2-WRDUHZ	23410	FDM2-WRDUWZ	23410	
GF Protection with external CT	Inbuilt	3MZ2-WRAUHZ	21935	3MZ2-WRAUWZ	21935	
	Inbuilt	3MZ2-WRCUHZ	21935	3MZ2-WRCUWZ	21935	
	Inbuilt	3MZ2-WRDUHZ	21935	3MZ2-WRDUWZ	21935	
	Extended**	FMZ2-WRAUHZ	26335	FMZ2-WRAUWZ	26335	
	Extended**	FMZ2-WRCUHZ	26335	FMZ2-WRCUWZ	26335	
	Extended**	FMZ2-WRDUHZ	26335	FMZ2-WRDUWZ	26335	
GF Protection with inbuilt CT	Inbuilt	3BZ2-WRAUHZ	31840			
	Inbuilt	3BZ2-WRCUHZ	31840			
	Extended**	FBZ2-WRAUHZ	32355			
	Extended**	FBZ2-WRCUHZ	32355			

Digital EOCR with Modbus Communication						
Current Range=0.5A-80A						
Control Voltage=100VAC-220VAC*						
Description	Display	Bottom Hole		Window Hole		
		Reference	Unit MRP [₹]	Reference	Unit MRP [₹]	
Without Ground Fault Protection	Inbuilt	I3DM-WRDUHZ	34775	I3DM-WRDUWZ	34775	
	Extended**	IFDM-WRDUHZ	35000	IFDM-WRDUWZ	35000	
GF Protection with external CT	Inbuilt	I3MZ-WRAUHZ	36980	I3MZ-WRAUWZ	36980	
	Inbuilt	I3MZ-WRCUHZ	36980	I3MZ-WRCUWZ	36980	
	Inbuilt	I3MZ-WRDUHZ	36980	I3MZ-WRDUWZ	36980	
	Extended**	IFMZ-WRAUHZ	41890	IFMZ-WRAUWZ	41890	
	Extended**	IFMZ-WRCUHZ	41890	IFMZ-WRCUWZ	41890	
	Extended**	IFMZ-WRDUHZ	41890	IFMZ-WRDUWZ	41890	
GF Protection with inbuilt CT	Inbuilt	I3BZ-WRAUHZ	42850			
	Inbuilt	I3BZ-WRCUHZ	42850			
	Extended**	IFBZ-WRAUHZ	43075			
	Extended**	IFBZ-WRCUHZ	43075			

* Replace **U** with **B** in above reference for Control Voltage =24 V DC
 ** Cable need to be purchased separately
 Contact Customer Care for 4-20mA Output EOCR references & prices

EOCR Accessories

Cable for Extended Display			
Description	Reference	Unit MRP [₹]	
 CABLE-RJ45 1 Meter	CABLE-RJ45-001	2500	
CABLE-RJ45 3 Meter	CABLE-RJ45-003	3265	

External CT for range extension up to 400A				
Current Range	CT Ratio	Reference	Unit MRP [₹]	
 100A	100:5	3CT-H1-100-Z	5510	
150A	150:5	3CT-HH-150-Z	6825	
200A	200:5	3CT-H2-200-Z	7455	
300A	300:5	3CT-H3-300-Z	7925	
400A	400:5	3CT-H4-400-Z	9325	

ZCT - Ground Fault Protection			
Description	Reference	Unit MRP [₹]	
 ZCT 35 M/M	ZCT-035-Z	6790	
ZCT 80 M/M	ZCT-080-Z	9325	
ZCT 120 M/M	ZCT-120-Z	15340	

Spare Display		
Description	Reference	Unit MRP [₹]
EOCR-PDM Display	EOCR-PDM	10335

For details on non standard references, technical parameters, accessories, compatibility, stockable and non stockable status please contact Customer Care

NORMAL STOCK ITEMS

W.E.F. January 17th, 2024

TeSys Protect

Analog EOCR

EOCR SS

- Without Display



Analog EOCR without Display			
Current Range (A)	Control Voltage	Reference	Unit MRP [₹]
0.5-6	24-240V AC/DC	EOCRSS-05S	6860
0.5-6	380-440V AC	EOCRSS-05W	5620
3-30	24-240V AC/DC	EOCRSS-30S	6860
3-30	380-440V AC	EOCRSS-30W	5620
5-60	24-240V AC/DC	EOCRSS-60S	6860
5-60	380-440V AC	EOCRSS-60W	5620

Note: 2 SPST output contacts
For 60A or higher, combine 05T Type and an external CT (secondary 5A) for use

EOCR SSD

- With Display (Operating Current & Trip Cause)



Analog EOCR with Display			
Current Range (A)	Control Voltage	Reference	Unit MRP [₹]
0.5-6	24-240V AC/DC	EOCRSSD-05S	10260
0.5-6	380-440V AC	EOCRSSD-05W	12635
3-30	24-240V AC/DC	EOCRSSD-30S	10260
3-30	380-440V AC	EOCRSSD-30W	10950
5-60	24-240V AC/DC	EOCRSSD-60S	10260
5-60	380-440V AC	EOCRSSD-60W	10950

Note: 2 SPST output contacts
For 60A or higher, combine 05T Type please an external CT (secondary 5A) for use

For details on non standard references, technical parameters, accessories, compatibility, stockable and non stockable status please contact Customer Care

NORMAL STOCK ITEMS

W.E.F. January 17th, 2024

TeSys Power

Circuit breakers for Motor protection

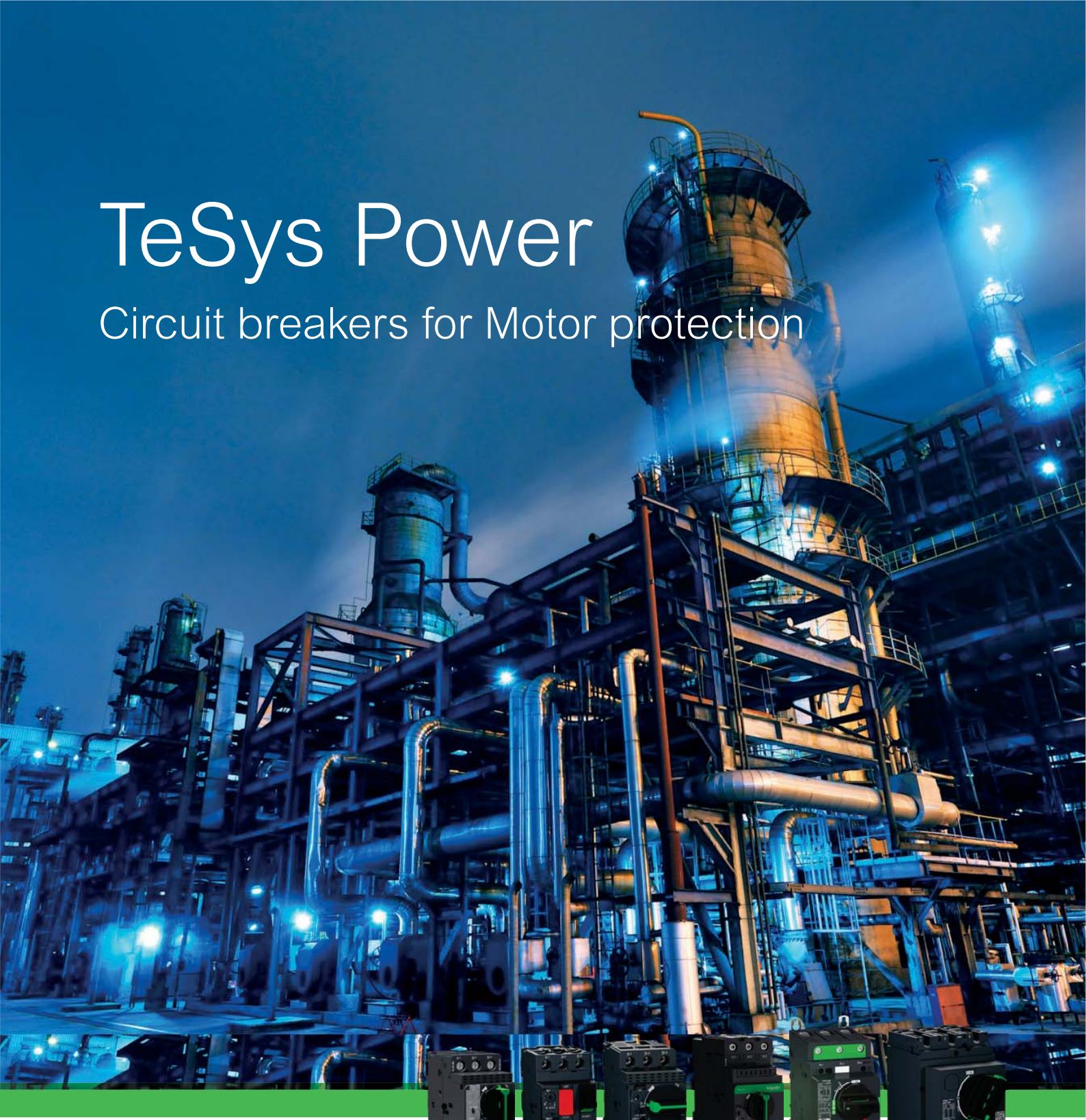

Circuit breakers for motor protection and control

TeSys Deca and TeSys Giga Circuit Breakers provide compact, reliable and efficient solutions:

- Isolation
- Protection against short circuits and overloads
- Control of motors from 0.06 to 250 kW.
- Conforming to global standards.(IEC/EN/UL/CSA)



For more information
on motor protection
circuit breakers

se.com/in/TeSys

TeSys Power

Circuit Breakers for Motor Protection

Magnetic Circuit Breaker



- Conformance to IEC 60947 -1,-2,-4
- Magnetic circuit breakers range from 0.1-80 Amps
- High Breaking capacity up to 100kA
- Wide range of accessories

Breaking Capacity at 415V 50Hz	Motor Power AC-3**		Magnetic Protection Rating (A)	Reference	Unit MRP [₹]
	kW	HP			
With Rocker Lever Control (Economy)*					
100kA	0.09	-	0.4	GV2LE03	5530
	0.18	-	0.63	GV2LE04	5530
	0.37	0.5	1	GV2LE05	5530
	0.55	-	1.6	GV2LE06	5530
	1.1	1.5	2.5	GV2LE07	5530
	1.5	2	4	GV2LE08	5530
	2.2	3	6.3	GV2LE10	5530
	3	5.5	10	GV2LE14	5530
15kA	5.5	7.5	14	GV2LE16	5530
	7.5	10	18	GV2LE20	6420
10kA	11	15	25	GV2LE22	6420
	15	20	32	GV2LE32	10905
With Rotary Handle Control*					
100kA	0.09	-	0.4	GV2L03	6345
	0.18	-	0.63	GV2L04	6345
	0.37	0.5	1	GV2L05	6345
	0.55	-	1.6	GV2L06	6345
	1.1	1.5	2.5	GV2L07	6345
	1.1	2	4	GV2L08	6345
	2.2	3	6.3	GV2L10	6345
	4	5.5	10	GV2L14	6345
50kA	5.5	7.5	14	GV2L16	6345
	7.5	10	18	GV2L20	6345
	11	15	25	GV2L22	6345
	15	20	32	GV2L32	6345
	18.5	25	40	GV3L40	17725
	22	29	50	GV3L50	18140
	30	40	65	GV3L65	18535
	37	50	73	GV3L73	20955
With Toggle Control					
50kA	37	50	80	GV4LE80N6	18105
	55	74	115	GV4LE115N6	18105
	75	101	150	C16N3MA150	On Request
	110	147	220	C25N3MA220	On Request
	160	214	320	C40N31M320	On Request
	200	268	500	C63N31M500	On Request

* Conforming to IEC 60947-2-3-4

** 50/60Hz - 415V

• GV2-L with the TeSys Deca contactor and LRD overload relay provides Type 2 Co-ordination

** 50/60Hz - 415V

(1) With GV1-L3 current limiter, breaking capacity can be increased to 100kA. Combination of the GV2-M with the TeSys Deca provides Type 2 Co-ordination.

(2) With GV1-L3 current limiter, breaking capacity can be increased to 100kA. Combination of the GV2-P with the TeSys Deca provides Type 2 Co-ordination.

Thermal Magnetic Circuit Breaker



- Conformance to IEC 60947 -1,-2,-4, conformity to International Standards - UL, CSA, CE
- Thermal magnetic circuit breakers range from 0.1-220 Amps
- High Breaking capacity up to 100kA
- Wide range of accessories
- S-shaped busbar for side-by-side connection with 40 - 65A Contactor

Breaking Capacity at 415V 50Hz	Motor Power AC-3**		Thermal Protection Adjustment Range	Reference	Unit MRP [₹]
	kW	HP			
With Push Button Control (Economy)					
100kA	-	-	0.1 - 0.16	GV2ME01	5740
	0.06	-	0.16 - 0.25	GV2ME02	5740
	0.09	-	0.25 - 0.40	GV2ME03	5740
	0.18	-	0.40 - 0.63	GV2ME04	6110
	0.37	0.5	0.63 - 1.0	GV2ME05	6110
	0.55	0.75	1.0 - 1.6	GV2ME06	6245
	0.75	1	1.6 - 2.5	GV2ME07	6245
	1.1	2	2.5 - 4	GV2ME08	6460
	2.2	3	4 - 6.3	GV2ME10	6460
	3	5.5	6 - 10	GV2ME14	6460
15kA ⁽¹⁾	5.5	7.5	9 - 14	GV2ME16	7240
	7.5	10	13 - 18	GV2ME20	7790
	9	12.5	17 - 23	GV2ME21	8320
10kA ⁽¹⁾	11	15	20 - 25	GV2ME22	8320
	15	20	24 - 32	GV2ME32	13475
With Rotary Handle Control					
100kA	-	-	0.1 - 0.16	GV2P01	5615
	0.06	-	0.16 - 0.25	GV2P02	5615
	0.09	-	0.25 - 0.40	GV2P03	5615
	0.18	-	0.40 - 0.63	GV2P04	6435
	0.37	0.5	0.63 - 1.0	GV2P05	6435
	0.55	0.75	1.0 - 1.6	GV2P06	6435
	0.75	1	1.6 - 2.5	GV2P07	6435
	1.1	2	2.5 - 4	GV2P08	6635
	2.2	3	4 - 6.3	GV2P10	6635
	3	5.5	6 - 10	GV2P14	7080
	5.5	7.5	9 - 14	GV2P16	8695
	7.5	10	13 - 18	GV2P20	10035
	9	12.5	17 - 23	GV2P21	10035
	11	15	20 - 25	GV2P22	10035
	15	20	24 - 32	GV2P32	16915
	50kA ⁽²⁾	18.5	30...40	30...40	GV3P40
22		37...50	37...50	GV3P50	24740
30		48...65	48...65	GV3P65	25375
37		62...73	62...73	GV3P73	25935
37		49.58	40...80	GV4PE80N6	23470
50kA	55	73.7	65...115	GV4PE115N6	23470
With Toggle Control					
70kA	75	101	70...150	GV5P150H	47730
	110	147	100...220	GV5P220H	55680
	160	214	160...320	GV6P320H	71600
	200	268	250...500	GV6P500H	98645

It is recommended to check with Customer care team for selection, recommendation, and availability of stockable and non stockable references

✓ NORMAL STOCK ITEMS

W.E.F. January 17th, 2024

TeSys Power

Circuit Breakers for Motor Protection

Accessories for Motor Circuit Breakers

Description	Reference	Unit MRP [₹]	
For GV2			
Front contact NO or NC ⁽¹⁾	GVAE1	1195	
Front contact NO + NC	GVAE11 <input checked="" type="checkbox"/>	1465	
	GVAE20	1615	
Side contact NO + NC	GVAN11 <input checked="" type="checkbox"/>	1765	
	GVAN20	1765	
Fault signalling contact + 1NO contact ⁽²⁾	GVAD1010 <input checked="" type="checkbox"/>	2300	
Fault signalling contact + 1NC contact ⁽²⁾	GVAD1001	2300	
Short circuit signalling contact block 1 C/O	GVAM11	2195	
Under voltage trip	110 ... 115V 50Hz	GVAU115	4735
	220 ... 240V 50Hz	GVAU225	4200
	380 ... 400V 50Hz	GVAU385	4200
Shunt trip	110 ... 115V 50Hz	GVAS115	4200
	220 ... 240V 50Hz	GVAS225	4200
	380 ... 400V 50Hz	GVAS385	4200
Additive limiter for increasing breaking capacity to 100kA for GV2ME and GV2P.	GV1L3	6775	
Connection block - GV2 with contactor LC1-D09..D38	GV2AF3	820	
Connection block - LS1 D32 or GV2 with Contactor LC1-K or LP1-K	GV2AF01	890	
Empty enclosure for GV2ME - plastic	GV2MP02	3905	
	GV2MC02	4290	

(1) Choice of NC or NO contact operation depending on which way round the reversible block is mounted.

(2) The GV-AD is always mounted next to the circuit breaker.

Busbars

Connection Pitch	No. of Tapoff Points	Reference	Unit MRP [₹]
For GV2			
45 mm	2	GV2G245	2300
	4	GV2G445	3620
54 mm	2	GV2G254	2100
	3	GV2G354	2360
	4	GV2G454	2955
72 mm	5	GV2G554	3200
	4	GV2G472	3620

Description	Reference	Unit MRP [₹]
Accessories for Busbars		
Terminal block - to supply one or more 3-pole busbar GV2	GV2G05	4535
Protective end covers for unused busbar outlets	GV1G10	800
Terminal block for connection from top	GV1G09	2370

Accessories for Motor Circuit Breakers

Description	Reference	Unit MRP [₹]
For GV2-P/GV2-L		
External operator - IP54, Black	GV2APN01 <input checked="" type="checkbox"/>	4165
External operator - IP54, Yellow/Red	GV2APN02	7755
For GV3P/GV3L		
Auxiliary Contacts		
Front contact: 1 NO (fault) + 1NC (Auxiliary)	GVAED011	1520
Front contact: 1 NO (fault) + 1NO (Auxiliary)	GVAED101	1670
Busbar		
3-pole, 3 tap, 64 mm pitch	GV3G364	2210
S-shape bus bar	GV3S	1655
External Operator		
IP54, Black	GV3APN01	5025
IP54, Yellow/Red	GV3APN02	4865

Note: All other accessories are same as of GV2.

Busbars GV3G364 and GV3S are not compatible with GV3*73 and GV3*80.

Description	Operating Voltage	Reference	Unit MRP [₹]
For GV5 and GV6			
Clip-on connector - upto 150 A - 1.5..95 mm ²	-	GV7AC021	1445
Clip-on connector- upto 220 A - 1.5..185 mm ²	-	GV7AC022	1990
Front rotary handle			
GV7AP GV7R - black handle ⁽²⁾		GV7AP01	10470
Terminal shields IP405 ⁽¹⁾	-	GV7AC01	3725

(1) Terminal shields cannot be used together with spreaders.

(2) For mounting direct rotary handle on enclosure door.

This accessory makes it possible to open the door if the device is closed and prevents the device from being closed if the door is open.

(3) For Circuit breaker not fitted with a rotary handle

It is recommended to check with Customer care team for selection, recommendation, and availability of stockable and non stockable references

NORMAL STOCK ITEMS

W.E.F. January 17th, 2024

TeSys

Accessories compatibility

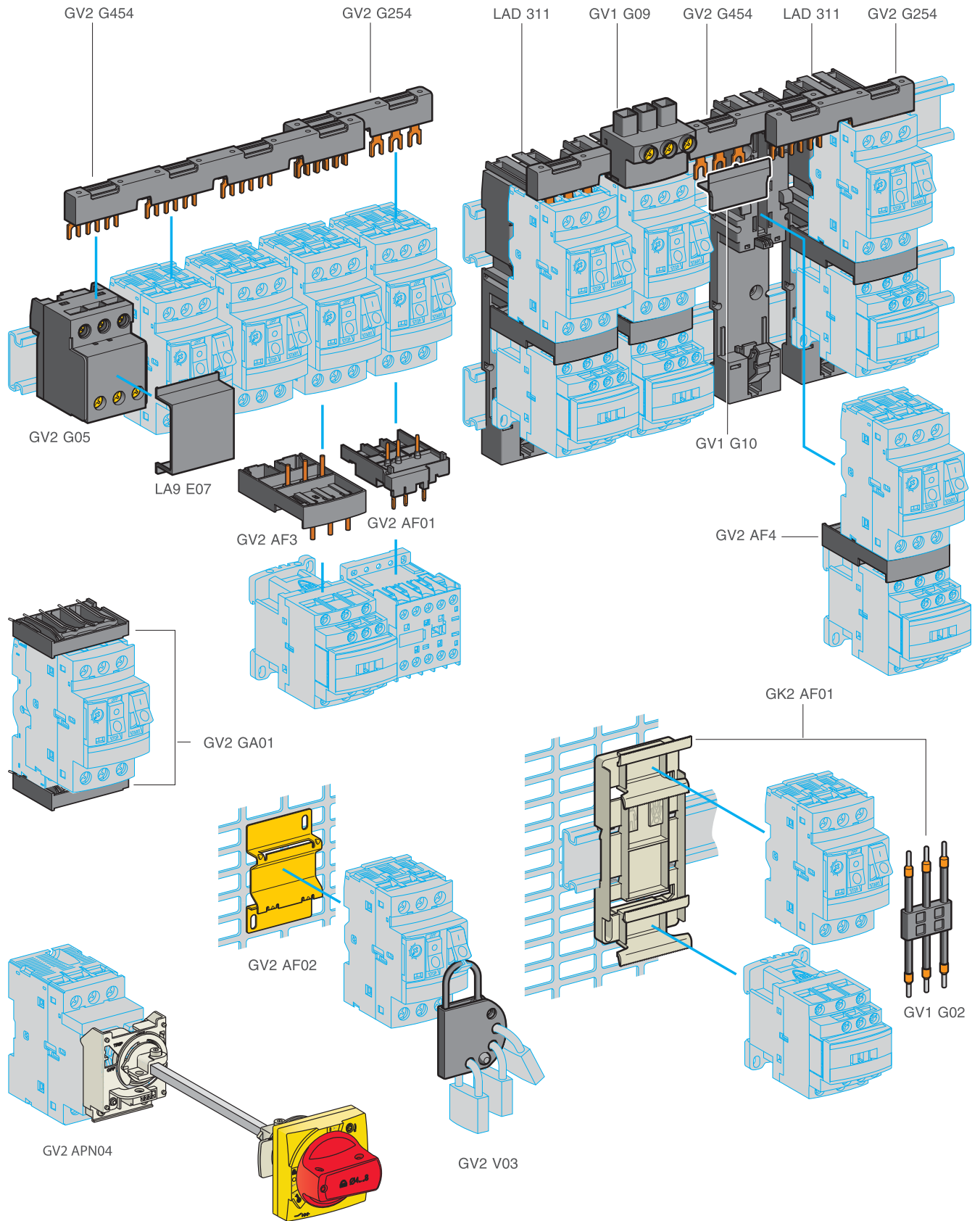

TeSys

Accessories compatibility

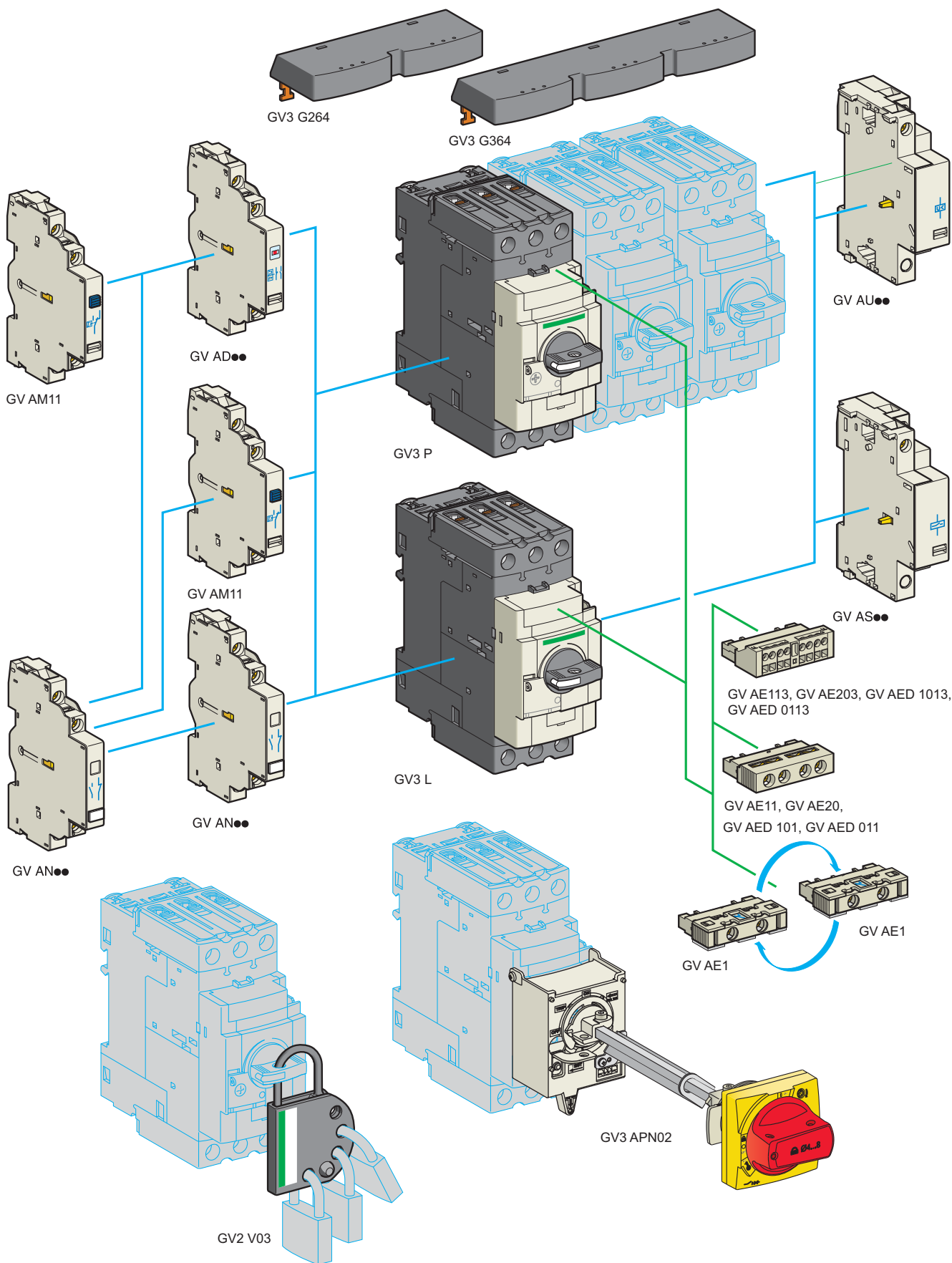

TeSys Control

TeSys Switches

Vario Switch Disconnectors

[Ithe] Conventional Thermal Current**	Poles Description	Rated Operational Power (AC-23)*	Reference	Unit MRP [₹]
Complete Enclosed Switches				
• Range 12 to 175A, IP 65 Sealable and Lockable				
10	3P	4 kW	VCF02GE	4110
16	3P	5.5 kW	VCF01GE	4470
20	3P	7.5 kW	VCF0GE	5435
25	3P	11 kW	VCF1GE	5830
32	3P	15 kW	VCF2GE	6830
50	3P	22 kW	VCF3GE	10565
63	3P	30 kW	VCF4GE	12360

* Rated Power at 415V
** Ith in enclosure

For Switch Type (Amps)	Mounting Arrangement	Ingress	Reference	Unit MRP [₹]
Operators (Padlockable)				
12 - 40	4 Screw Fixing	IP65	KCF1PZ	1175
63 - 80	4 Screw Fixing	IP65	KCF2PZ	1245
125 - 175	4 Screw Fixing	IP40	KCF3PZ	5030

Vario Switch Disconnectors

[Ithe] Conventional Thermal Current**	Poles Description	Reference	Unit MRP [₹]
Complete Switch with Padlockable Operator			
• Suitable for Front Mounting or Base Mounting			
12	3P	VCF02	2580
20	3P	VCF01	2810
25	3P	VCF0	3275
32	3P	VCF1	3435
40	3P	VCF2	4255
63	3P	VCF3	8620
80	3P	VCF4	7215
125	3P	VCF5	16530
175	3P	VCF6	20040
Switch Bodies			
12		V02	1680
20		V01	1940
25		V0	2305
32		V1	2810
40		V2	3435
63		V3	4780
80		V4	6285
125		V5	12750
175		V6	16275

Accessories

Description	For Use with Switch Bodies	Rating in A	Pole Composition	Earth Contact	Auxiliary Contacts	Reference	Unit MRP [₹]
Vario Add-on Modules (1)							
Main Pole Module	V02/VCF02	12	1P	-	-	VZ02	1205
	V01/VCF01	20	1P	-	-	VZ01	1225
	V0/VCF0	25	1P	-	-	VZ0	1305
	V1/VCF1	32	1P	-	-	VZ1	1275
	V2/VCF2	40	1P	-	-	VZ2	1365
	V3/VCF3	63	1P	-	-	VZ3	1775
	V4/VCF4	80	1P	-	-	VZ4	1775
Neutral Pole Module(2)	V02 / VCF02 to V2 / VCF2	-	1N	-	-	VZ11	1465
	V3 / VCF3 to V4 / VCF4	-	1N	-	-	VZ12	1960
	V5 / VCZ5 to V6 / VCZ6	-	1N	-	-	VZ13	4050
Earthing Module	V02 / VCF02 to V2 / VCF20	-	-	-	-	VZ14	1445
	V3 / VCF3 to V4 / VCF4	-	-	1	-	VZ15	1705
	V5 / VCZ5 to V6 / VCZ6	-	-	1	-	VZ16	2650
Auxiliary Contact Block Module	V02/ VCF02 to V6 / VCZ6	-	-	-	1NO + 1NC	VZ7	1510
	V2/ VCF02 to V6 / VCZ6	-	-	-	2NO	VZ20	1510

(1) For mounting option of modules, please refer to the technical catalogue.
(2) With early make and late break contacts

Description	For Use With	Reference	Unit MRP [₹]
Components for Door Interlocking			
Shaft extension - for Mini-VARIO and VARIO - V02..V2	V02...V2	VZ17	1445
	V02...V2	VZ30	1705
Shaft extension - for Mini-VARIO and VARIO - V3 V4 V5 V6	V3, V4, V5, V6	VZ18	1705
	V3, V4, V5, V6	VZ31	1940
Door interlock plate	VZ17 / VZ30	KZ32	500
	VZ18/31	KZ74	860
Input Terminal Protection Shrouds			
Terminal Shrouds	V02 - V2	VZ8	490
	V3 - V4	VZ26	425
	V3 - V4	VZ9	515
	V5 - V6	VZ27	425
	V5 - V6	VZ10	645
	V02 - V6	VZ28	720
	V02 - V6	VZ29	590

For details on non standard references, technical parameters, accessories, compatibility, stockable and non stockable status please contact Customer Care

NORMAL STOCK ITEMS

W.E.F. January 17th, 2024

TeSys Control

Accessories for Switches

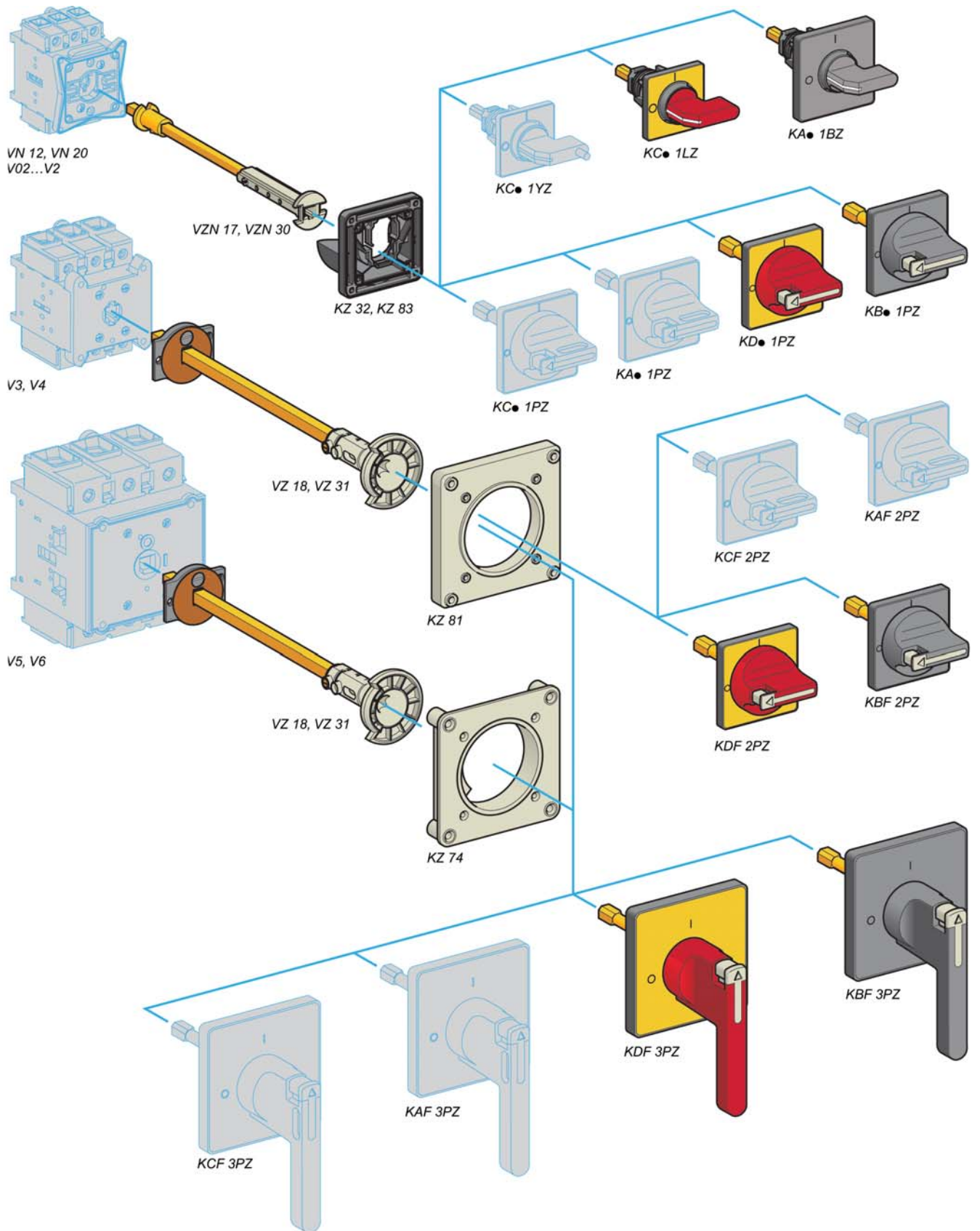



Smarter Load Management with TeSys Island

The Key to Unprecedented Efficiency

Digital Load Manager

TeSys Island - the innovative & digital multifunctional load management solution up to 80A

Industry 4.0

Predictive Maintenance

Cyber Secure



TeSys Active

TeSys Island

• All-in-one Solution for Versatile & Flexible Load Management •

Motor Protection

- Motor Overload
- Over/Under Current
- Jam/Stall
- Long Start
- Rapid Restart Lockout

Upstream Protection

- Phase Loss
- Phase Reversal
- Phase Unbalance
- Ground Current Detection

Analytics

- Health Diagnostic
- Energy Management
- Demand Management

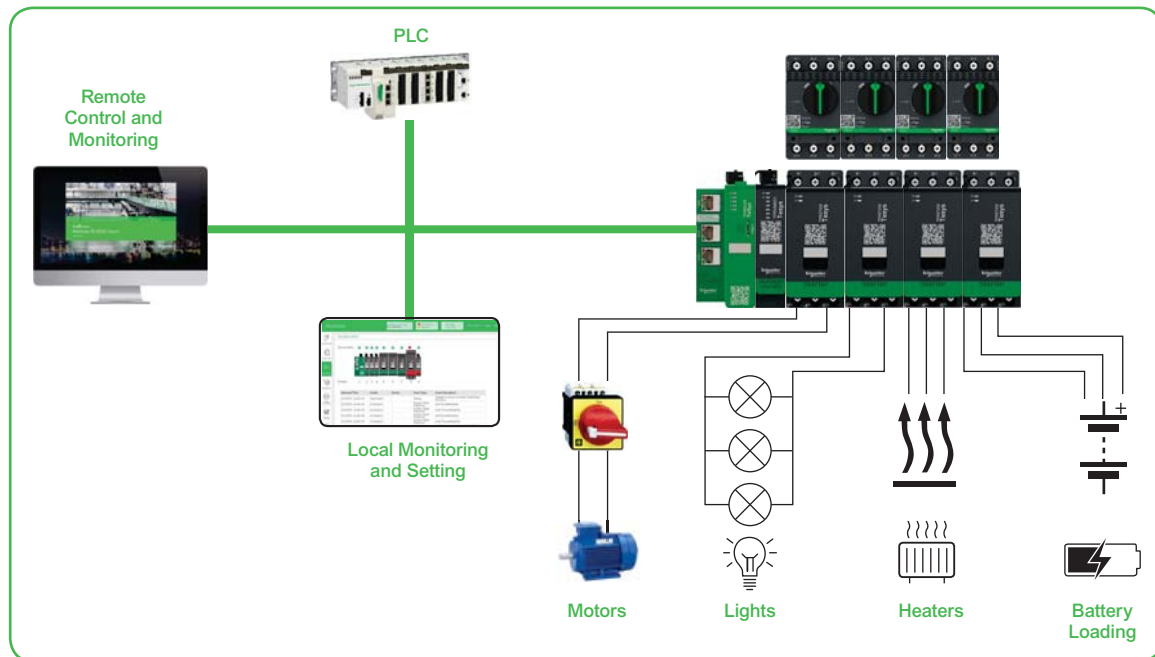

Designation	Product Specification	Commercial Reference
TeSys island components		
Standard Starter	9A (AC-3)	TPRST009
Standard Starter	25A (AC-3)	TPRST025
Standard Starter	38A (AC-3)	TPRST038
Standard Starter	65A (AC-3)	TPRST065
Standard Starter	66A (AC-3) - 80A (AC-1)	TPRST080
SIL Starter	9A (AC-3)	TPRSS009
SIL Starter	25A (AC-3)	TPRSS025
SIL Starter	38A (AC-3)	TPRSS038
SIL Starter	65A (AC-3)	TPRSS065
SIL Starter	66A (AC-3) - 80A (AC-1)	TPRSS080
Power interface module	9A (AC-3)	TPRPM009
Power interface module	38A (AC-3)	TPRPM038
Power interface module	80A (AC-3)	TPRPM080
Voltage interface module		TPRVM001
SIL interface module		TPRSM001
Digital I/O module	(4 input - 2 output)	TPRDG4X2
Analog I/O module	(2 input - 1 output)	TPRAN2X1
Bus Coupler	EtherNet/IP - Modbus TCP	TPRBCEIP
Bus Coupler	PROFINET	TPRBCPFN
Bus Coupler	PROFIBUS	TPRBCPF8
Assembly and Wiring Kits		
Kit for reversing starter application	for 9, 25, 38A (size 1 and 2) starters	LAD9R1
Kit for reversing starter application	for 65, 80A (size 3) starters	LAD9R3
Jumper bar 3-pole for Star Delta application	for 9, 25, 38A (size 1 and 2) starters	LAD9P3
Kit for reversing starter application	for 65, 80 A (size 3) starters, a hazard sticker is provided	LAD9SD3S

*Architecture shown above is only for graphical representation

TeSys Control

Ultra motor starters

Introduction

From traditional solution



Ultra motor starter- All in one block for advance protection

Motor circuit breaker:
GV2L



Magnetic protection
> short-circuit protection

Contactor:
LC1D



Control
> Start/Stop

Status monitoring
> signaling
> alarm monitoring

Protection relay:
LRD



Thermal protection
> overload



Ultra motor starter
> All basic or advanced protection and control functions in one block

and more...

- > Overload indication and alarm
- > Status report, remote control via communication bus

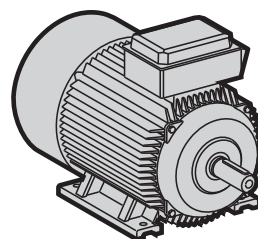

Ultra motor starters
can be used in
80 %
of motor protection and control applications.

TeSys Control

Ultra motor starters



- Total Coordinated Starter – 3 functions in a single device
- Compact Starter, DOL / RDOL upto 18.5kW (38A, AC-3) in 45mm width
- Direct connectivity to Modbus / Profibus / CANopen / DeviceNet
- Higher switching life - 15Million operations, 2Million AC-43 electrical life
- Breaking capacity upto 130kA



Power Base

For assembling components, ON/OFF operation and resetting.
 > 3 power bases:
 upto 12A and upto 38A
 > Direct starter and reversing starter models.

Control Unit

Performs all the electrical protection functions to cover main applications from 0 to 38A.

Some of these also provide advanced measurement, alarm and display functions.

4 simple function modules

Thermal overload alarm Indication of motor load
 Thermal overload signalling and manual reset
 Thermal overloaded signalling and automatic or remote reset.

4 communication modules

Profibus DP
 CANopen
 DeviceNet
 Modbus.

40%

“TeSys solutions allow us to reduce the size of our enclosure” says a panel builder from the water treatment sector

60%

“Late customization means that we can build 60% of the panels, even though the project design has not yet been completed” says an engineer in a food processing industry

Quick Selection

Select 1	+	Select 1	Optional	or	Optional	or	Optional																																																																																																																																																		
Base Power Unit Non-Reversing <table border="1"> <tr><td>LUB</td><td>120</td></tr> <tr><td>0.. 12A with terminal</td><td>12</td></tr> <tr><td>0.. 12A no terminal</td><td>120*</td></tr> <tr><td>0.. 32A with terminal</td><td>32</td></tr> <tr><td>0.. 32A no terminal</td><td>320*</td></tr> <tr><td>0.. 38A with terminal</td><td>38</td></tr> <tr><td>0.. 38A no terminal</td><td>380*</td></tr> </table> Reversing <table border="1"> <tr><td>LU2B</td><td>120</td><td>BL</td></tr> <tr><td>0.. 12A with terminal</td><td>12</td><td></td></tr> <tr><td>0.. 12A no terminal</td><td>120*</td><td></td></tr> <tr><td>0.. 32A with terminal</td><td>32</td><td></td></tr> <tr><td>0.. 32A no terminal</td><td>320*</td><td></td></tr> <tr><td>0.. 38A with terminal</td><td>38</td><td></td></tr> <tr><td>0.. 38A no terminal</td><td>380*</td><td></td></tr> <tr><td>24 V DC</td><td></td><td>BL</td></tr> <tr><td>24 V AC</td><td></td><td>B</td></tr> <tr><td>48...72 VAC or 48 VDC</td><td></td><td>ES</td></tr> <tr><td>110...240 VAC/DC</td><td></td><td>FU</td></tr> </table> *Prewired cables to be ordered separately	LUB	120	0.. 12A with terminal	12	0.. 12A no terminal	120*	0.. 32A with terminal	32	0.. 32A no terminal	320*	0.. 38A with terminal	38	0.. 38A no terminal	380*	LU2B	120	BL	0.. 12A with terminal	12		0.. 12A no terminal	120*		0.. 32A with terminal	32		0.. 32A no terminal	320*		0.. 38A with terminal	38		0.. 38A no terminal	380*		24 V DC		BL	24 V AC		B	48...72 VAC or 48 VDC		ES	110...240 VAC/DC		FU		Control Unit <table border="1"> <tr><td>LUC</td><td>B</td><td>X6</td><td>BL</td></tr> <tr><td>Class 10, 3Ph</td><td>B</td><td></td><td></td></tr> <tr><td>Class 10, 1Ph</td><td>C</td><td></td><td></td></tr> <tr><td>Class 20, 3Ph</td><td>D</td><td></td><td></td></tr> <tr><td>0.15 to 0.6 A</td><td></td><td>X6</td><td></td></tr> <tr><td>0.35 to 1.4 A</td><td></td><td>1X</td><td></td></tr> <tr><td>1.25 to 5 A</td><td></td><td>05</td><td></td></tr> <tr><td>3 to 12 A</td><td></td><td>12</td><td></td></tr> <tr><td>4.5 to 18 A</td><td></td><td>18</td><td></td></tr> <tr><td>8 to 38 A</td><td></td><td>38</td><td></td></tr> <tr><td>24V DC</td><td></td><td></td><td>BL</td></tr> <tr><td>24VAC</td><td></td><td></td><td>B</td></tr> <tr><td>48...72 VAC/48 VDC</td><td></td><td></td><td>ES</td></tr> <tr><td>110...240VAC/DC</td><td></td><td></td><td>FU</td></tr> </table>	LUC	B	X6	BL	Class 10, 3Ph	B			Class 10, 1Ph	C			Class 20, 3Ph	D			0.15 to 0.6 A		X6		0.35 to 1.4 A		1X		1.25 to 5 A		05		3 to 12 A		12		4.5 to 18 A		18		8 to 38 A		38		24V DC			BL	24VAC			B	48...72 VAC/48 VDC			ES	110...240VAC/DC			FU	Communication Module* <table border="1"> <tr><td>LULC</td><td>033</td></tr> <tr><td>Modbus Serial</td><td>033</td></tr> <tr><td>Profibus DP</td><td>07</td></tr> <tr><td>CANopen</td><td>08</td></tr> <tr><td>DeviceNet</td><td>09</td></tr> </table>	LULC	033	Modbus Serial	033	Profibus DP	07	CANopen	08	DeviceNet	09	or	Function Module <table border="1"> <tr><td>LUF</td><td>DH11</td></tr> <tr><td>Fault diff. with manual reset</td><td>DH11</td></tr> <tr><td>Fault diff. with auto reset</td><td>DA10</td></tr> <tr><td>Thermal overload pre-alarm</td><td>W10</td></tr> <tr><td>Motor load indication (4-20mA)</td><td>V2</td></tr> </table>	LUF	DH11	Fault diff. with manual reset	DH11	Fault diff. with auto reset	DA10	Thermal overload pre-alarm	W10	Motor load indication (4-20mA)	V2	or	Auxiliary Contacts Contactor auxiliary contacts <table border="1"> <tr><td>LUFN</td><td>11</td></tr> <tr><td>1NO + 1NC</td><td>11</td></tr> <tr><td>2NC</td><td>02</td></tr> <tr><td>2NO</td><td>20</td></tr> <tr><td>Side contacts 2NO</td><td>LUA8E20</td></tr> </table> Power auxiliary contacts (trip status) <table border="1"> <tr><td>LUA1C</td><td>20</td></tr> <tr><td>1NO + 1NC</td><td>11</td></tr> <tr><td>2NO</td><td>20</td></tr> </table>	LUFN	11	1NO + 1NC	11	2NC	02	2NO	20	Side contacts 2NO	LUA8E20	LUA1C	20	1NO + 1NC	11	2NO	20	Accessories <table border="1"> <thead> <tr><th>Description</th><th>Reference</th></tr> </thead> <tbody> <tr><td>Line spacer for UL508 Type E</td><td>LU9SPO</td></tr> <tr><td>Current limiter 130kA@460V</td><td>LUALB1</td></tr> </tbody> </table>	Description	Reference	Line spacer for UL508 Type E	LU9SPO	Current limiter 130kA@460V	LUALB1
LUB	120																																																																																																																																																								
0.. 12A with terminal	12																																																																																																																																																								
0.. 12A no terminal	120*																																																																																																																																																								
0.. 32A with terminal	32																																																																																																																																																								
0.. 32A no terminal	320*																																																																																																																																																								
0.. 38A with terminal	38																																																																																																																																																								
0.. 38A no terminal	380*																																																																																																																																																								
LU2B	120	BL																																																																																																																																																							
0.. 12A with terminal	12																																																																																																																																																								
0.. 12A no terminal	120*																																																																																																																																																								
0.. 32A with terminal	32																																																																																																																																																								
0.. 32A no terminal	320*																																																																																																																																																								
0.. 38A with terminal	38																																																																																																																																																								
0.. 38A no terminal	380*																																																																																																																																																								
24 V DC		BL																																																																																																																																																							
24 V AC		B																																																																																																																																																							
48...72 VAC or 48 VDC		ES																																																																																																																																																							
110...240 VAC/DC		FU																																																																																																																																																							
LUC	B	X6	BL																																																																																																																																																						
Class 10, 3Ph	B																																																																																																																																																								
Class 10, 1Ph	C																																																																																																																																																								
Class 20, 3Ph	D																																																																																																																																																								
0.15 to 0.6 A		X6																																																																																																																																																							
0.35 to 1.4 A		1X																																																																																																																																																							
1.25 to 5 A		05																																																																																																																																																							
3 to 12 A		12																																																																																																																																																							
4.5 to 18 A		18																																																																																																																																																							
8 to 38 A		38																																																																																																																																																							
24V DC			BL																																																																																																																																																						
24VAC			B																																																																																																																																																						
48...72 VAC/48 VDC			ES																																																																																																																																																						
110...240VAC/DC			FU																																																																																																																																																						
LULC	033																																																																																																																																																								
Modbus Serial	033																																																																																																																																																								
Profibus DP	07																																																																																																																																																								
CANopen	08																																																																																																																																																								
DeviceNet	09																																																																																																																																																								
LUF	DH11																																																																																																																																																								
Fault diff. with manual reset	DH11																																																																																																																																																								
Fault diff. with auto reset	DA10																																																																																																																																																								
Thermal overload pre-alarm	W10																																																																																																																																																								
Motor load indication (4-20mA)	V2																																																																																																																																																								
LUFN	11																																																																																																																																																								
1NO + 1NC	11																																																																																																																																																								
2NC	02																																																																																																																																																								
2NO	20																																																																																																																																																								
Side contacts 2NO	LUA8E20																																																																																																																																																								
LUA1C	20																																																																																																																																																								
1NO + 1NC	11																																																																																																																																																								
2NO	20																																																																																																																																																								
Description	Reference																																																																																																																																																								
Line spacer for UL508 Type E	LU9SPO																																																																																																																																																								
Current limiter 130kA@460V	LUALB1																																																																																																																																																								

*Suitable with 24V DC starter variant only

Note: For prices please contact Customer Care

Wherever productivity is a concern, intelligence to Motor Control is the solution



TeSys T Intelligence system optimises the operational performance of LV motors through advanced protections and embedded intelligent functions inside intelligent Motor Control Centre (iMCC)





Tesys T Motor Management Systems

TeSys T covers all load monitoring and protection needs from feeders to critical process automation through advanced diagnostics, statistics, and alarms that help in anticipating unexpected production halts and minimize downtime. In addition, the system's connectivity and access to real-time data provides key information to enhance the efficiency, operation and safety of the process.

TeSys T Controller:

Intelligent motor controller for 1P/3P Motors with built in CT up to 100Amps with accurate monitoring and protection functions, 6DI, 4DO, 1CBCT input, 1 Temperature probe

Protection Functions:

- Thermal overload
- Phase imbalance and phase overloads
- Temperature monitoring via probes
- Phase reversal
- Ground fault detection
- Long start and Jam protection
- Load shedding
- Load fluctuations
- power factor monitoring

Monitoring Functions:

- Phase and average current
- Line to Line and average voltage
- Motor temperature, ground current
- Active and Reactive Energy
- Frequency & Power Factor
- Detailed Fault history
- Fault counts
- motor statistics

Control Functions:

- Local / Remote / HMI control
- Predefined programs for DOL, RDOL, Star-delta, two-speed starters

Communication:



Quick Selection

TeSys T Controller



Reference			
LTM R	100	E	BD

Current Range	0.4 - 8 A	
	08	27
	5 - 100 A	

Network Protocol	CAN Open	
	C	D
	Ethernet IP / Modbus TCP/IP	
	E	M
	Profibus DP	

Control Voltage	24 V DC	
	BD	FM
110-240V AC		



TeSys T
Full and Flexible
Intelligent Motor
Management System

TeSys T Accessories

TeSys T Expansion Module^{1,2}



Control Voltage	Reference
24 V DC	LTM EV40BD
110V AC	LTM EV40FM

¹ Required for Voltage & Power measurement
² 4 digital inputs

Operator Control Display



Description	Reference
Operator Control Display with configuration backup	LTM CUF

Connector for Expansion



Length (m)	Reference
0.04	LTMCC004 ³

³ Sold in lots of 6

Controller to Display Cable



Length (m)	Reference
1.0	LTM9CU10
3.0	LTM9CU30

Ground Fault CT's



Primary [A]	Internal Ø "d" [mm]	Reference
65	30	50437
85	50	50438
160	80	50439
250	120	50440
400	200	50441
630	300	50442

Current Transformers⁴



Primary [A]	Secondary [A]	Reference
100	1	LT6 CT1001
200	1	LT6 CT2001
400	1	LT6 CT4001
800	1	LT6 CT8001

Description	Composition	Reference
Programming software SoMove	1 Program for each PC	On request
PC connecting cable	USB to RS485 Converter	TCSMCNAM3M002P

Note: For prices please contact Customer Care

se.com/in

53 Life Is On Schneider Electric

Type 2 Co-ordination chart with TeSys range

Type 2 co-ordination chart for Direct-On-Line starter with circuit breaker and overload protection built into the circuit breaker

Reliable switching for IE2/IE3/IE4 motors



IE2



IE3



IE4

Rated operational voltage, $U_e = 400/415V, 50/60Hz$
Short Circuit Current (I_q) = 50kA

Sr. No.	3Φ Motor power in kW	Current in A	Circuit Breaker	Setting range of thermal trips (A)	Contactor
1	0.06	0.2	GV2P02 or GV2ME02	0.16...0.25	LC1D09
2	0.09	0.3	GV2P03 or GV2ME03	0.25...0.4	LC1D09
3	0.12	0.44	GV2P04 or GV2ME04	0.4...0.63	LC1D09
4	0.18	0.6	GV2P04 or GV2ME04	0.4...0.63	LC1D09
5	0.25	0.85	GV2P05 or GV2ME05	0.63...1	LC1D09
6	0.37	1.0	GV2P05 or GV2ME05	0.63...1	LC1D09
7	0.55	1.5	GV2P06 or GV2ME06	1...1.6	LC1D09
8	0.75	1.9	GV2P07 or GV2ME07	1.6...2.5	LC1D09
9	1.1	2.7	GV2P08 or GV2ME08	2.5...4	LC1D09
10	1.5	3.6	GV2P08 or GV2ME08	2.5...4	LC1D09
11	2.2	4.9	GV2P10 or GV2ME10	4...6.3	LC1D09
12	3	6.5	GV2P14 or GV2ME14	6...10	LC1D09
13	4	8.5	GV2P14 or GV2ME14	6...10	LC1D09
14	5.5	11.5	GV2P16	9...14	LC1D25
15	7.5	15.5	GV2P20	13...18	LC1D25
16	9	18.1	GV2P21	17...23	LC1D25
17	11	22	GV2P22	20...25	LC1D25
18	15	29	GV2P32	25...40	LC1D32
19	18.5	35	GV3P40	30...40	LC1D50A
20	22	41	GV3P50	37...50	LC1D50A
21	30	55	GV3P65	48...65	LC1D65A
22	37	66	GV4PE/PEM80 ^{*(2)}	62...73	LC1D80
23	45	80	GV4PE/PEM115 ^{*(2)}	65...115	LC1D115
24	55	97	GV4PE/PEM115 ^{*(2)}	65...115	LC1D115
25	75	132	GV5P150 ^{*(2)}	70...150	LC1D150
26	90	160	GV5P220 ^{*(2)}	100...220	LC1G185
27	110	195	GV5P220 ^{*(2)}	100...220	LC1G225
28	132	230	GV6P320 ^{*(2)}	160...320	LC1G265
29	160	280	GV6P320 ^{*(2)}	160...320	LC1G330
30	220	385	GV6P500 ^{*(2)}	250...500	LC1G500
31	250	450	GV6P500 ^{*(2)}	250...500	LC1G500

(1) The breaking performance of circuit-breakers GV2 P can be increased by adding a current limiter GV1 L3

(2) Reference to be completed by replacing the * with the breaking performance code as per table given below:

Circuit breaker type	GV5P150*	GV5P220*	GV5P320*	GV6P500*	GV4PE/PEM80*	GV4PE/PEM115*
Breaking performance I_q (kA) at 400/415V	70	70	70	70	50	50
Breaking performance code	H	H	H	H	N	N

For advanced protection, protection with Electronic Overcurrent Relays, heavy starting, please contact our sales teams.

Type 2 Co-ordination chart

Type 2 co-ordination chart for Direct-On-Line starter with circuit breaker and separate thermal overload relay

Reliable switching for IE2/IE3/IE4 motors



IE2



IE3

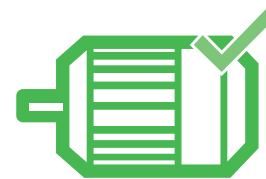

IE4

Rated operational voltage, $U_e = 400/415V, 50/60Hz$
Short Circuit Current (I_q) = 50kA

Sr. No.	3 Φ Motor power in kW	Current in Amps	Circuit Breaker	Contactor	Overload relay	
					Type	Range (A)
1	0.06	0.2	GV2L03 or GV2LE03	LC1D09	LRD02	0.16...0.25
2	0.09	0.3	GV2L03 or GV2LE03	LC1D09	LRD03	0.25...0.40
3	0.12	0.44	GV2L04 or GV2LE04	LC1D09	LRD04	0.4...0.63
4	0.18	0.6	GV2L04 or GV2LE04	LC1D09	LRD04	0.4...0.63
5	0.25	0.85	GV2L05 or GV2LE05	LC1D09	LRD05	0.63...1
6	0.37	1.0	GV2L05 or GV2P06	LC1D09	LRD05	0.63...1
7	0.55	1.5	GV2L06 or GV2LE06	LC1D09	LRD06	1...1.7
8	0.75	1.9	GV2L07 or GV2LE07	LC1D09	LRD07	1.6...2.5
9	1.1	2.7	GV2L08 or GV2LE08	LC1D09	LRD08	2.5...4
10	1.5	3.6	GV2L08 or GV2LE08	LC1D09	LRD08	2.5...4
11	2.2	4.9	GV2L10 or GV2LE10	LC1D09	LRD10	4...6
12	3	6.5	GV2L14 or GV2LE14	LC1D09	LRD12	5.5...8
13	4	8.5	GV2L14 or GV2LE14	LC1D09	LRD14	7...10
14	5.5	11.5	GV2L16	LC1D25	LRD16	9...13
15	7.5	15.5	GV2L20	LC1D25	LRD21	12...18
16	9	18.1	GV2L22	LC1D25	LRD22	16...24
17	11	22	GV2L22	LC1D25	LRD22	16...24
18	15	29	GV3L32	LC1D40A	LRD332	23...32
19	18.5	35	GV3L40	LC1D50A	LRD340	30...40
20	22	41	GV3L50	LC1D50A	LRD350	37...50
21	30	55	GV3L65	LC1D65A	LRD365	48...65
22	37	66	GV4L/LE80 ⁽¹⁾	LC1D80	LRD3363	63...80
23	45	80	GV4L/LE115 ⁽¹⁾	LC1D115	LR9D5367	60...100
24	55	97	GV4L/LE115 ⁽¹⁾	LC1D115	LR9D5369	90...150
25	75	132	NSX160*MA ⁽¹⁾	LC1D150	LR9D5369	90...150
26	90	160	NSX250*MA ⁽¹⁾	LC1G185	LR9G225	57...225
27	110	195	NSX250*MA ⁽¹⁾	LC1G225	LR9G225	57...225
28	132	230	NSX400* + Mic 1.3M ⁽¹⁾	LC1G265	LR9G500	125...500
29	160	280	NSX400* + Mic 1.3M ⁽¹⁾	LC1G330	LR9G500	125...500
30	200	350	NSX630* + Mic 1.3M ⁽¹⁾	LC1G400	LR9G500	125...500
31	220	388	NSX630* + Mic 1.3M ⁽¹⁾	LC1G500	LR9G500	125...500
32	250	430	NSX630* + Mic 1.3M ⁽¹⁾	LC1G500	LR9G500	125...500

(1) Reference to be completed by replacing the * with the breaking performance code as per table given below:

Circuit breaker type	NSX100*MA	NSX160*MA, NSX250*MA	NSX400* NSX630*	GV4L/LE80*	GV4L/LE115*
Breaking performance I_q (kA) at 400/415V	50	50	50	50	50
Breaking performance code	N	N	N	N	N

For advanced protection, protection with Electronic Overcurrent Relays, heavy starting, please contact our sales teams.

Type 2 Co-ordination chart

Type 2 co-ordination chart for Star Delta starters with circuit-breaker and separate thermal overload relay

Reliable switching for IE2/IE3/IE4 motors



IE2



IE3



IE4

Rated operational voltage, $U_e = 400/415V, 50/60Hz$

Short Circuit Current (I_q) = 50kA

Sr. No.	3 Φ Motor power in kW	Line current in Amps	Phase current in Amps	Circuit Breaker	Main/Delta Contactor	Star Contactor	Overload Relay	
							Type	Range (A)
1	5.5	11.5	6.6	GV2L16	LC1D25	LC1D09	LRD12	5.5..8
2	7.5	15.5	8.9	GV2L20	LC1D25	LC1D09	LRD14	7..10
3	9	18.1	10.5	GV2L22	LC1D25	LC1D09	LRD16	9..13
4	11	22	12.7	GV2L22	LC1D25	LC1D09	LRD21	12..18
5	15	29	16.7	GV3L32	LC1D40A	LC1D09	LRD318	12..18
6	18.5	35	20.2	GV3L40	LC1D50A	LC1D09	LRD325	17..25
7	22	41	23.7	GV3L50	LC1D50A	LC1D18	LRD332	23..32
8	30	55	31.8	GV3L65	LC1D65A	LC1D18	LRD340	30..40
9	37	66	38.1	GV3L73	LC1D80A	LC1D32	LRD350	37..50
10	37	66	38.1	GV4L/LE80 ⁽¹⁾	LC1D80A	LC1D32	LRD3357	37..50
11	45	80	46.2	GV4L/LE115 ⁽¹⁾	LC1D115	LC1D65A	LRD3357	37..50
12	55	97	56	GV4L/LE115 ⁽¹⁾	LC1D115	LC1D65A	LRD3359	48..65
13	75	132	76.2	NSX160*MA150 ⁽¹⁾	LC1D150	LC1D65A	LR9D5367	60 ... 100
14	90	160	92.4	NSX250*MA220 ⁽¹⁾	LC1G115	LC1D65	LR9G115	28 ... 115
15	110	195	112.6	NSX250*MA220 ⁽¹⁾	LC1G150	LC1D80	LR9G225	57 ... 225
16	132	230	132.8	NSX400*Mic 1.3M ⁽¹⁾	LC1G150	LC1D80	LR9G225	57 ... 225
17	160	280	161.7	NSX400*Mic 1.3M ⁽¹⁾	LC1G185	LC1D115	LR9G225	57 ... 225
18	200	350	202.1	NSX630*Mic 1.3M ⁽¹⁾	LC1G225	LC1G150	LR9G225	57 ... 225
19	220	388	224	NSX630*Mic 1.3M ⁽¹⁾	LC1G265	LC1G150	LR9G500	125 ... 500
20	250	430	248.3	NSX630*Mic 1.3M ⁽¹⁾	LC1G265	LC1G150	LR9G500	125 ... 500

(1) Reference to be completed by replacing the * with the breaking performance code as per table given below:

Circuit breaker type	NSX100*MA	NSX160*MA, NSX250*MA	NSX400* NSX630*	GV4L/LE80*	GV4L/LE115*
Breaking performance I_q (kA) at 400/415V	50	50	50	50	50
Breaking performance code	N	N	N	N	N

For advanced protection, protection with Electronic Overcurrent Relays, heavy starting, please contact our sales teams.

Type 2 Co-ordination chart

Type 2 co-ordination chart for Star Delta starter with circuit breaker and overload protection built into circuit breaker

Reliable switching for IE2/IE3/IE4 motors



IE2



IE3



IE4

Rated operational voltage, $U_e = 400/415V, 50/60Hz$
Short Circuit Current (I_q) = 50kA / 70kA as per table

Sr. No.	3 Φ Motor power in kW	Line current in Amps	Phase current in Amps	I_q (kA)	Circuit Breaker	Main/Delta Contactor	Star Contactor
1	5,5	11.5	6.6	50	GV2P16	LC1D25	LC1D09
2	7,5	15.5	8.9	50	GV2P20	LC1D25	LC1D09
3	9	18.1	10.5	50	GV2P21	LC1D25	LC1D09
4	11	22	12.7	50	GV2P22	LC1D25	LC1D09
5	15	29	16,7	50	GV3P32	LC1D40A	LC1D09
6	18,5	35	20.2	50	GV3P40	LC1D50A	LC1D09
7	22	41	23.7	50	GV3P50	LC1D50A	LC1D18
8	30	55	31.8	50	GV3P65	LC1D65A	LC1D32
9	37	66	38.1	50	GV3P73	LC1D80A	LC1D32
10	37	66	38.1	70	GV4PE/PEM80 ^{*(1)}	LC1D80A	LC1D32
11	45	80	46.2	70	GV4PE/PEM115 ^{*(1)}	LC1D115	LC1D65A
12	55	97	56.0	70	GV4PE/PEM115 ^{*(1)}	LC1D115	LC1D65A
13	75	132	76.2	70	GV5P150 ^{*(1)}	LC1 D150	LC1D150
14	90	160	92.4	70	GV5P220 ^{*(1)}	LC1 G115	LC1D65
15	110	195	112.6	70	GV5P220 ^{*(1)}	LC1 G150	LC1D80
16	132	230	132.8	70	GV6P320 ^{*(1)}	LC1G150	LC1D95
17	160	280	161.7	70	GV6P320 ^{*(1)}	LC1G185	LC1G115
18	220	388	224.0	70	GV6P500 ^{*(1)}	LC1G265	LC1G150
19	250	430	248.3	70	GV6P500 ^{*(1)}	LC1G265	LC1G150

(1) Reference to be completed by replacing the * with the breaking performance code as per table given below:

Circuit breaker type	GV5P150*	GV5P220*	GV5P320*	GV6P500*	GV4PE/PEM80*	GV4PE/PEM115*
Breaking performance I_q (kA) at 400/415V	70	70	70	70	50	50
Breaking performance code	H	H	H	H	N	N

Type 2 Co-ordination chart with TeSys range (With TeSys G Contactors and Relays)

Type 2 co-ordination chart for Direct-On-Line starter with circuit breaker and overload protection built into the circuit breaker

Reliable switching for IE2/IE3/IE4 motors



IE2



IE3



IE4

Rated operational voltage, $U_e = 400/415V, 50/60Hz$
Short Circuit Current (I_q) = 50kA

45 to 250 kW at 400/415V: type 2 coordination (with ref. GV4, GV5, GV6 circuit breakers)							
Sr. No.	Standard power ratings of 3-phase motors 50/60 Hz in category AC-3e			Circuit breaker			Contactor
	400/415V			Reference ⁽¹⁾	I _r Setting	I _{rm}	Reference
	P	I _e	I _q (max)				
	kW	A	kA	A	A		
1	45	80	100	GV4P/GV4PE/GV4PEM115●	86	1118	LC1G115
2	55	97	100	GV4P115●	100	1300	LC1G115
3	55	97	70	GV5P150●	100	1300	LC1G115
4	75	132	70	GV5P150●	140	1820	LC1G150
5	90	160	70	GV5P220●	170	2210	LC1G185
6	110	195	70	GV5P220●	200	2600	LC1G225
7	110	195	70	GV6P320●	200	2600	LC1G265
8	132	230	70	GV6P320●	240	3120	LC1G265
9	160	280	70	GV6P320●	300	3900	LC1G330
10	200	350	70	GV6P500●	380	4940	LC1G400
11	220	380	70	GV6P500●	400	5200	LC1G500
12	250	430	70	GV6P500●	440	5720	LC1G500

(1) Reference to be completed by replacing the ● with the breaking performance code:

Breaking performance I_q (kA)

Code	GV4P/GV4PE/GV4PEM115●			GV5P150●/ 220● GV6P320●/ 500●	
	B	N	S	F	H
400/415V	25	50	100	36	70

Type 2 Co-ordination chart with TeSys range (With TeSys G Contactors and Relays)

Type 2 co-ordination chart for Direct-On-Line starter with circuit breaker and separate relay

Reliable
switching for
IE2/IE3/IE4
motors



IE2



IE3

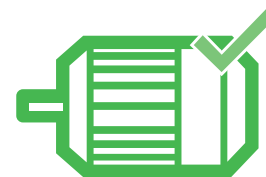

IE4

Rated operational voltage, $U_e = 400/415V, 50/60Hz$
Short Circuit Current (I_q) = 50kA

45 to 335 kW at 400/415V: type 2 coordination (with ref GV4, or NSX circuit breakers)								
Sr. No.	Standard power ratings of 3-phase motors 50/60 Hz in category AC-3e			Circuit breaker		Contactor	Contactor	
	400/415V			Reference ⁽¹⁾	I _{rm}	Reference	Reference	Ir Setting
	P	I _e	I _q (max)					
kW	A	kA		A			A	
1	45	80	100	GV4L/GV4LE115●	1265	LC1G115	LR9G115	80
2	55	97	100	GV4L/GV4LE115●	1100	LC1G115	LR9G225	80
3	45	80	130	NSX100● + MA	1265	LC1G115	LR9G115	97
4	55	97	130	NSX160● + MA	1500	LC1G115	LR9G225	97
5	75	132	130	NSX160● + MA	1800	LC1G150	LR9G225	132
6	90	160	130	NSX250● + MA	2640	LC1G185	LR9G225	160
7	110	195	130	NSX250● + MA	2640	LC1G225	LR9G225	195
8	110	195	130	NSX400● + Micrologic 1.3M	3520	LC1G265	LR9G500	195
9	132	230	130	NSX400● + Micrologic 1.3M	3520	LC1G265	LR9G500	230
10	160	280	130	NSX400● + Micrologic 1.3M	3840	LC1G330	LR9G500	280
11	200	350	130	NSX630● + Micrologic 1.3M	5500	LC1G400	LR9G500	350
12	220	380	130	NSX630● + Micrologic 1.3M	5500	LC1G500	LR9G500	380
13	250	430	130	NSX630● + Micrologic 1.3M	6000	LC1G500	LR9G500	430
14	300	460	130	NS800● + Micrologic 5	8800	LC1G630	LR9G630	460
15	335	575	130	NS800● + Micrologic 5	9600	LC1G630	LR9G630	575

(1) Reference to be completed by replacing the ● with the breaking performance code:

Breaking performance I_q (kA)

Code	GV4L115●/ GV4LE115●			NSX100●/ NSX160●/ NSX250●/ NSX400●/ NSX630●				NS800●		
	B	N	S	F	N	H	R	N	H	L
400/415V	25	50	100	36	50	70	200	50	70	150

Magnetic circuit breakers + Contactor + TeSys T + current transformers

90 to 250 kW at 400/415V: type 2 coordination									
Sr. No.	Standard power ratings of 3-phase motors 50/60 Hz in category AC-3e			Circuit breaker		Contactor	TeSys T Motor management controller	Current transformers	
	400/415V			Reference ⁽¹⁾	Rating I _{rm}	Reference	Reference ⁽²⁾	Ir Setting	Reference
	P	I _e	I _q (max)						
kW	A	kA		A			A		
1	90	160	130	NSX250● + MA	2200	LC1G185	LTMR08●●	160	LT6CT2001
2	110	195	130	NSX250● + MA	2640	LC1G225	LTMR08●●	195	LT6CT2001
3	132	230	130	NSX400● + Micrologic 1.3M	3200	LC1G265	LTMR08●●	230	LT6CT4001
4	150	280	130	NSX400● + Micrologic 1.3M	3840	LC1G330	LTMR08●●	280	LT6CT4001
5	200	350	130	NSX630● + Micrologic 1.3M	5000	LC1G400	LTMR08●●	350	LT6CT4001
6	220	388	130	NSX630● + Micrologic 1.3M	5500	LC1G500	LTMR08●●	388	LT6CT4001
7	250	430	130	NSX630● + Micrologic 1.3M	6000	LC1G500	LTMR08●●	430	LT6CT8001

(1) Reference to be completed by replacing the ● with the breaking performance code:

Breaking performance I_q (kA)

Code	NSX250●/ NSX400●/ NSX630●			
	F	N	H	R
400/415V	36	50	70	200

Type 2 Co-ordination chart with TeSys range (With TeSys G Contactors and Relays)

Type 2 co-ordination chart for Star Delta starter with circuit breaker and overload protection built into circuit breaker

Reliable switching for IE2/IE3/IE4 motors



IE2



IE3



IE4

Rated operational voltage, $U_e = 400/415V, 50/60Hz$
Short Circuit Current (I_q) = 50kA / 70kA as per table

Contactor: **Maximum operating rate:** 30 starts/hour - **Maximum starting time:** 30 seconds.
The coordination table is for normal starting conditions (Class 10e/ 20e). For other heavy starting applications with long start times, please contact technical support.
RE17RMMWS timer to be used for Star-Delta starter application.

90 to 250 kW at 400/415V: type 2 coordination								
Sr. No.	Standard power ratings of 3-phase motors 50/60 Hz in category AC-3			Circuit breaker			Contactor Line/ Delta	Contactor Star
	400/415V			Reference ⁽¹⁾	Ir Setting	Irm	Reference	
	P kW	Ie A	Iq (max) kA					
1	90	160	70	GV5P220●	170	1360	LC1G115	LC1D65
2	110	195	70	GV5P220●	200	1600	LC1G150	LC1D80
3	110	195	70	GV6P320●	200	1600	LC1G150	LC1D80
4	132	230	70	GV6P320●	240	1920	LC1G150	LC1D95
5	160	280	70	GV6P320●	300	2400	LC1G185	LC1G115
6	200	350	70	GV6P500●	380	3040	LC1G225	LC1G115
7	220	380	70	GV6P500●	400	3200	LC1G265	LC1G150
8	250	430	70	GV6P500●	440	3520	LC1G265	LC1G150

(1) Reference to be completed by replacing the ● with the breaking performance code:

Breaking performance Iq (kA)

Code	GV5P220● GV6P320●/GV6P500●	
	F	H
400/415V	36	70

90 to 450 kW at 400/415V: type 2 coordination								
Sr. No.	Standard power ratings of 3-phase motors 50/60 Hz in category AC-3			Circuit breaker			Contactor Line/ Delta	Contactor Star
	400/415V			Reference ⁽¹⁾	Ir Setting	Irm	Reference	
	P kW	Ie A	Iq (max) kA					
1	90	160	130	NSX250● + Micrologic 2.2M	170	1360	LC1G115	LC1D65
2	110	195	130	NSX250● + Micrologic 2.2M	200	1600	LC1G150	LC1D80
3	110	195	130	NSX400● + Micrologic 2.3M	200	1600	LC1G150	LC1D80
4	132	230	130	NSX400● + Micrologic 2.3M	240	1920	LC1G150	LC1D95
5	160	280	130	NSX400● + Micrologic 2.3M	300	2400	LC1G185	LC1G115
6	200	350	130	NSX630● + Micrologic 2.3M	380	3040	LC1G225	LC1G115
7	220	380	130	NSX630● + Micrologic 2.3M	400	3200	LC1G265	LC1G150
8	250	430	130	NSX630● + Micrologic 2.3M	440	3520	LC1G265	LC1G150
9	300	460	130	NS800● + Micrologic 5	480	3840	LC1G330	LC1G185
10	335	575	130	NS800● + Micrologic 5	640	5120	LC1G400	LC1G225
11	355	610	130	NS800● + Micrologic 5	640	5120	LC1G400	LC1G225
12	400	690	130	NS800● + Micrologic 5	720	5760	LC1G500	LC1G265
13	450	770	130	NS1000● + Micrologic 5	784	6272	LC1G500	LC1G330

(1) Reference to be completed by replacing the ● with the breaking performance code:

Breaking performance Iq (kA)

Code	NSX250●/ NSX400●/ NSX630●				NS800●/ NS1000●		
	F	N	H	R	N	H	L
400/415V	36	50	70	200	50	70	150

Type 2 Co-ordination chart with TeSys range (With TeSys G Contactors and Relays)

Type 2 Co-ordination chart for Direct-On-Line starter with circuit breaker and separate thermal overload relay

Reliable switching for IE2/IE3/IE4 motors



IE2



IE3



IE4

Contactor: **Maximum operating rate:** 30 starts/hour - **Maximum starting time:** 30 seconds.

The coordination table is for normal starting conditions (Class 10e/ 20e). For other heavy starting applications with long start times, please contact technical support.

RE17RMMWS timer to be used for Star-Delta starter application.

90 to 450 kW at 400/415V: type 2 coordination

Sr. No.	Standard power ratings of 3-phase motors 50/60 Hz in category AC-3			Circuit breaker		Contactor Line/ Delta	Contactor Star	Thermal overload relay	
	400/415V			Reference ⁽¹⁾	I _{rm}	Reference		Reference	Setting range
	P	I _e	I _q (max)						
	kW	A	kA	A	A				
1	90	160	130	NSX250● + MA	1980	LC1G115	LC1D65	LR9G115	92
2	110	195	130	NSX250● + MA	1980	LC1G150	LC1D80	LR9G225	113
3	110	195	130	NSX400● + Micrologic 1.3M	1920	LC1G150	LC1D80	LR9G225	113
4	132	230	130	NSX400● + Micrologic 1.3M	1920	LC1G150	LC1D80	LR9G225	133
5	160	280	130	NSX400● + Micrologic 1.3M	2560	LC1G185	LC1G115	LR9G225	162
6	200	350	130	NSX630● + Micrologic 1.3M	3000	LC1G225	LC1G150	LR9G225	202
7	220	380	130	NSX630● + Micrologic 1.3M	3500	LC1G265	LC1G150	LR9G500	219
8	250	430	130	NSX630● + Micrologic 1.3M	3500	LC1G265	LC1G150	LR9G500	248
9	300	460	130	NS800● + Micrologic 5	4000	LC1G330	LC1G185	LR9G500	266
10	335	575	130	NS800● + Micrologic 5	4800	LC1G400	LC1G225	LR9G500	332
11	355	610	130	NS800● + Micrologic 5	5600	LC1G400	LC1G225	LR9G500	352
12	400	627	130	NS800● + Micrologic 5	5600	LC1G400	LC1G225	LR9G500	362
13	450	695	130	NS800● + Micrologic 5	6400	LC1G500	LC1G265	LR9G500	401

(1) Reference to be completed by replacing the ● with the breaking performance code:

Breaking performance I_q (kA)

Code	NSX250●/ NSX400●/ NSX630●				NS800●		
	F	N	H	R	N	H	L
400/415V	36	50	70	200	50	70	150

Type 2 Recommended Selection Charts for Motor Feeder with EasyPact

Notes:

- Selection is for Normal Starting time (Relay Trip classes 10A/10) applications.
- Overload relay type LRE and EOCR both can be used. However, while using EOCR, setting of Trip class in EOCR should be up to 10/10A only.
- For high Inertia loads like Blowers, Pumps & ID/FD fans etc., if taking longer starting time, kindly consult us to derive the selection. However, this selection can still be used if these applications accept relay trip class 10A/10.
- Service factor of the motors considered is 1
- Selection is directly valid for Switching & Protection of Motors which comply to IS: 12615 efficiency class and can also be used for other non-standard motors whose starting current is less than or equal to starting currents as described in IS: 12615
- The rated motor current used for derivation is Full Load Current (FLC) for 3-phase, 4 Pole Squirrel Cage Induction Motors as indicated in IS: 12615. Selection can also be used for 2 Pole, 6 Pole and 8 Pole Motors based on rated motor current.
- Higher ratings of Contactors can be used in place of recommended combinations.
- These charts are derived basis Type-2 Methodology described in IEC 60947-4, Clause B.4.5.
- For Star-Delta Motor feeders, In-side delta wiring is considered.
- For Star Delta Motor feeders, proper Change-over time and Pause time must be ensured. Selected combination of Motor feeders components in this chart are valid only and only when used along with timer MSMI06 and equivalent timer from Schneider.
- This selection is valid only for suggested Product combinations. Change in any of the recommended combination including timer will invalidate the recommendations and Human safety, Installation safety and product safety requirements may not be fulfilled.
- In case of motor feeders with Circuit breaker, ensure proper Instantaneous setting as suggested in respective charts, if any.
- Max. Operating rate per Hour for contactors & Circuit breaker for Motor protection shall not be exceeded.
- Product evolution and improvement is a Continuous process at Schneider Electric. Hence, recommendations and guidelines are subject to change. Contact Schneider Electric for latest guidelines.

Contact our Customer Care for application specific Custom / optimised selection for your motor feeders having motors with service factor more than 1, longer starting time applications, Closed transition star delta starters, other than 400/415V perational voltages, starting currents / inrush currents lower than specified in IS 12615

Selection Chart

Direct-on-Line starters with circuit-breaker and overload protection built into the circuit-breaker
Type GZ1E

Reliable
switching for
IE2/IE3 motors



IE2



IE3

Rated Operational Voltage, $U_e = 400/415V, 50/60Hz$
Short Circuit Current $I_q = 50kA$

Type-2 Recommended Selection

Sr. No.	3Φ Motors			I _q Current (kA)	Contactor	Overload Relay		Circuit Breaker	
	kW	HP	FLC - I _n (Amps)			Type	Range (A)	Type	Rating (A)
1	0.06	x	0.19	50	LC1E09	In-built in Circuit Breaker		GZ1E02	0.16 - 0.25
2	0.09	x	0.28	50	LC1E09		GZ1E03	0.25 - 0.4	
3	0.12	0.16	0.51	50	LC1E09		GZ1E04	0.4 - 0.63	
4	0.18	0.25	0.6	50	LC1E09		GZ1E04	0.4 - 0.63	
5	0.25	0.33	0.8	50	LC1E09		GZ1E05	0.63 - 1	
6	0.37	0.5	1.4	50	LC1E09		GZ1E06	1 - 1.6	
7	0.55	0.75	1.7	50	LC1E09		GZ1E07	1.6 - 2.5	
8	0.75	1	2.2	50	LC1E09		GZ1E07	1.6 - 2.5	
9	1.1	1.5	2.9	50	LC1E09		GZ1E08	2.5 - 4	
10	1.3	1.75	3	50	LC1E09		GZ1E08	2.5 - 4	
11	1.5	2	3.8	50	LC1E09		GZ1E08	2.5 - 4	
12	2.2	3	5.1	50	LC1E18		GZ1E10	4 - 6.3	
13	3	4	6	50	LC1E18		GZ1E14	6 - 10	
14	3.7	5	8.1	50	LC1E25		GZ1E14	6 - 10	
15	4	5.5	8.5	50	LC1E25		GZ1E14	6 - 10	
16	5.5	7.5	11.4	50*	LC1E32		GZ1E16	9 - 14	
17	7.5	10	15.4	50*	LC1E32		GZ1E20	13 - 18	
18	9.3	12.5	17.3	50*	LC1E40B		GZ1E21	17 - 23	
19	11	15	22	50*	LC1E40B		GZ1E22	20 - 25	
20	13	17.5	24	50*	LC1E50		GZ1E32	24 - 32	
21	15	20	30	50*	LC1E50		GZ1E32	24 - 32	

* 50kA With current Limiter type GV1L3, 10kA without current limiter

Selection Chart

Direct-On-Line starters with circuit-breaker GZL 1LE and separate thermal overload relay

Reliable
switching for
IE2/IE3 motors



IE2



IE3

Rated Operational Voltage, $U_e = 400/415V, 50/60Hz$
Short Circuit Current $I_q = 50kA$ upto 4kw and above 4kw with 50kA
With current Limiter type GV1L3, 10kA without current limiter

Type-2 Recommended Selection

Sr. No.	P (kW)	I_e (A)	Circuit Breaker	Contactor	Thermal Overload relay	Range (A)
1	0.09	0.4	GZ1LE03	LC1E09	LRE03	0.25...0.40
2	0.18	0.63	GZ1LE04	LC1E09	LRE04	0.4...0.63
3	0.25	1	GZ1LE05	LC1E09	LRE05	0.63...1
4	0.37	1.4	GZ1LE06	LC1E09	LRE06	1...1.6
5	0.75	2.2	GZ1LE07	LC1E09	LRE07	1.6...2.5
6	1.5	3.8	GZ1LE08	LC1E09	LRE08	2.5...4
7	2.2	5.1	GZ1LE10	LC1E18	LRE10	4...6
8	4	8.5	GZ1LE14	LC1E25	LRE14	7...10
9	5.5	11.4	GZ1LE16	LC1E32	LRE16	9...13
10	7.5	15.4	GZ1LE20	LC1E32	LRE21	12...18
11	9.3	17.3	GZ1LE22	LC1E40	LRE22	16...24
12	11	22	GZ1LE22	LC1E40	LRE22	16...24
13	15	30	GZ1LE32	LC1E50	LRE32	23...32

Star Delta starters with circuit-breaker GZL 1LE and separate thermal overload relay

Type-2 Recommended Selection

Sr. No.	P (kW)	I_e (A)	$I_e/1,73$ (A)	Circuit Breaker	Main/Delta Contactor	Star Contactor	Thermal Overload Relay	
1	0.09	0.4	0.2	GZ1LE03	LC1E09	LC1E09	LRE02	0.16...0.25
2	0.18	0.63	0.4	GZ1LE04	LC1E09	LC1E09	LRE03	0.25...0.40
3	0.25	1	0.6	GZ1LE05	LC1E09	LC1E09	LRE04	0.4...0.63
4	0.37	1.4	0.8	GZ1LE06	LC1E09	LC1E09	LRE05	0.63...1
5	0.75	2.2	1.3	GZ1LE07	LC1E09	LC1E09	LRE06	1...1.6
6	1.5	3.8	2.2	GZ1LE08	LC1E09	LC1E09	LRE07	1.6...2.5
7	2.2	5.1	2.9	GZ1LE10	LC1E18	LC1E09	LRE08	2.5...4
8	4	8.5	4.9	GZ1LE14	LC1E25	LC1E09	LRE10	4...6
9	5.5	11.4	6.6	GZ1LE16	LC1E32	LC1E09	LRE12	5.5...8
10	7.5	15.4	8.9	GZ1LE20	LC1E32	LC1E09	LRE14	7...10
11	9.3	17.3	10.0	GZ1LE22	LC1E40B	LC1E18	LRE16	9...13
12	11	22	12.7	GZ1LE22	LC1E40B	LC1E18	LRE16	9...13
13	15	30	17.3	GZ1LE32	LC1E50	LC1E18	LRE21	12...18

Selection Chart

Direct-on-Line starters with Fuses and overload protection by separate overload relay type LRE (thermal) or EOCR** (up to Trip class 10/10A)

Reliable
switching for
IE2 motors



IE2

Rated Operational Voltage, $U_e = 400/415V, 50/60Hz$
Short Circuit Current $I_q = 50kA$

Type-2 Recommended Selection

Sr. No.	3Φ Motors			Contactor	Overload Relay		Nominal Back-up Fuse			SDF
	kW	HP	FLC - I_n (Amps)		Type	Range (A)	Fuse	Fuse Rating	Fuse Size	
1	0.12	0.16	0.51	LC1E09	LRE04	0.4-0.63	4NHG000B	4	000	NX032
2	0.18	0.25	0.6	LC1E09	LRE04	0.4-0.63	4NHG000B	4	000	NX032
3	0.25	0.33	0.8	LC1E09	LRE05	0.63-1	4NHG000B	4	000	NX032
4	0.37	0.5	1.4	LC1E09	LRE06	1-1.6	4NHG000B	4	000	NX032
5	0.55	0.75	1.7	LC1E09	LRE06	1-1.6	4NHG000B	4	000	NX032
6	0.75	1	2.2	LC1E09	LRE07	1.6-2.5	6NHG000B	6	000	NX032
7	1.1	1.5	2.9	LC1E09	LRE08	2.5-4	10NHG000B	10	000	NX032
8	1.3	1.75	3	LC1E09	LRE08	2.5-4	10NHG000B	10	000	NX032
9	1.5	2	3.8	LC1E09	LRE08	2.5-4	10NHG000B	10	000	NX032
10	2.2	3	5.1	LC1E09	LRE10	4-6	16NHG000B	16	000	NX032
11	3	4	6	LC1E09	LRE12	5.5-8	20NHG000B	20	000	NX032
12	3.7	5	8.1	LC1E09	LRE14	7-10	20NHG000B	20	000	NX032
13	4	5.5	8.5	LC1E09	LRE14	7-10	20NHG000B	20	000	NX032
14	5.5	7.5	11.4	LC1E12	LRE16	9-13	25NHG000B	25	000	NX032
15	7.5	10	15.4	LC1E18	LRE21	12-18	32NHG000B	32	000	NX063
16	9.3	12.5	17.3	LC1E25	LRE22	16-24	50NHG000B	50	000	NX063
17	11	15	22	LC1E25	LRE22	16-24	50NHG000B	50	000	NX063
18	13	17.5	24	LC1E32	LRE32	23-32	50NHG000B	50	000	NX063
19	15	20	30	LC1E32	LRE32	23-32	63NHG000B	63	000	NX063
20	18.5	25	36	LC1E40	LRE355	30-40	80NHG000B	80	000	NX080
21	22	30	43	LC1E50	LRE357	37-50	80NHG000B	80	000	NX080
22	30	40	56	LC1E65	LRE359	48-65	100NHG000B	100	000	NX100
23	37	50	69	LC1E80	LRE363	63-80	125NHG000B	125	00	NX125
24	45	60	84	LC1E95	LRE365	80-104	160NHG000B	160	00	NX160
25	55	75	99	LC1E120	LRE482	84-135	160NHG000B	160	00	NX160
26	75	100	134	LC1E160	LRE483*	124-198	250NHG1B	250	1	NX250
27	80	110	139	LC1E160	LRE483*	124-198	250NHG1B	250	1	NX250
28	90	120	164	LC1E200	LRE483	124-198	250NHG1B	250	1	NX250
29	110	150	204	LC1E250	LRE484	146-234	250NHG1B	250	1	NX250
30	125	170	234	LC1E250	LRE485	174-279	315NHG2B	315	2	NX315
31	132	180	247	LC1E250	LRE485	174-279	315NHG2B	315	2	NX315
32	160	215	288	LC1E300	LRE486	208-333	400NHG2B	400	2	NX400
33	180	240	298	LC1E300	LRE486	208-333	400NHG2B	400	2	NX400
34	200	270	348	LC1E400	LRE487	258-414	400NHG2B	400	2	NX400
35	225	300	360	LC1E400	LRE487	258-414	500NHG3B	500	3	NX630
36	250	335	435	LC1E500	LRE488	321-513	630NHG3B	630	3	NX630
37	275	370	440	LC1E500	LRE488	321-513	630NHG3B	630	3	NX630
38	315	425	548	LC1E630	LRE489	394-630	800NHG3B	800	3	NA
39	335	452	580	LC1E630	LRE489	394-630	800NHG3B	800	3	NA

* Relay can match with contactor electrically (i.e Cannot be directly mounted), rest all relays are suitable for direct mounting as per catalogue.

** Selection valid upto Trip class 10/10A, Contact Customer Care for details of EOCR to be used with this selection charts.

Selection Chart

Star Delta starters with Fuses and overload protection by separate overload relay type LRE (thermal) or EOCR** (up to Trip class 10/10A)

Reliable switching for IE2 motors



IE2

Rated Operational Voltage, $U_e = 400/415V, 50/60Hz$
Short Circuit Current $I_q = 50kA$

Type-2 Recommended Selection

Sr. No.	3Φ Motors				Contactor			Overload Relay		Nominal Back-up Fuse			SDF	Minimum Pause time* (mSec)
	kW	HP	FLC - I_n (Amps)					Type	Range (A)	Fuse type	Fuse Rating	Fuse Size		
			Line	Phase	Main	Delta	Star							
1	0.75	1	2.2	1.3	LC1E09	LC1E09	LC1E09	LRE06	1-1.6	4NHG000B	4	000	NX032	50
2	1.1	1.5	2.9	1.7	LC1E09	LC1E09	LC1E09	LRE07	1.6-2.5	4NHG000B	4	000	NX032	50
3	1.3	1.75	3	1.7	LC1E09	LC1E09	LC1E09	LRE07	1.6-2.5	4NHG000B	4	000	NX032	50
4	1.5	2	3.8	2.2	LC1E09	LC1E09	LC1E09	LRE07	1.6-2.5	6NHG000B	6	000	NX032	50
5	2.2	3	5.1	2.9	LC1E09	LC1E09	LC1E09	LRE08	2.5-4	10NHG000B	10	000	NX032	50
6	3	4	6	3.5	LC1E09	LC1E09	LC1E09	LRE08	2.5-4	10NHG000B	10	000	NX032	50
7	3.7	5	8.1	4.7	LC1E09	LC1E09	LC1E09	LRE10	4-6	10NHG000B	10	000	NX032	50
8	4	5.5	8.5	4.9	LC1E09	LC1E09	LC1E09	LRE10	4-6	16NHG000B	16	000	NX032	50
9	5.5	7.5	11.4	6.6	LC1E09	LC1E09	LC1E09	LRE12	5.5-8	16NHG000B	16	000	NX032	50
10	7.5	10	15.4	8.9	LC1E09	LC1E09	LC1E09	LRE14	7-10	20NHG000B	20	000	NX032	50
11	9.3	12.5	17.3	10.0	LC1E12	LC1E12	LC1E09	LRE14	7-10	20NHG000B	20	000	NX032	50
12	11	15	22	12.7	LC1E18	LC1E18	LC1E09	LRE16	9-13	32NHG000B	32	000	NX032	50
13	15	20	30	17.3	LC1E18	LC1E18	LC1E09	LRE21	12-18	40NHG000B	40	000	NX063	50
14	18.5	25	36	20.8	LC1E25	LC1E25	LC1E09	LRE22	16-24	40NHG000B	40	000	NX063	50
15	22	30	43	24.8	LC1E25	LC1E25	LC1E25	LRE32	23-32	50NHG000B	50	000	NX063	50
16	30	40	56	32.3	LC1E40	LC1E40	LC1E25	LRE355	30-40	63NHG000B	63	000	NX063	50
17	37	50	69	39.8	LC1E50	LC1E50	LC1E32	LRE355	30-40	80NHG000B	80	000	NX080	50
18	45	60	84	48.5	LC1E50	LC1E50	LC1E32	LRE357	37-50	100NHG000B	100	00	NX125	50
19	55	75	99	57.2	LC1E65	LC1E65	LC1E40	LRE359	48-65	125NHG000B	125	00	NX125	50
20	75	100	134	77.4	LC1E80	LC1E80	LC1E65	LRE363	63-80	160NHG000B	160	00	NX160	50
21	80	110	139	80.3	LC1E80	LC1E80	LC1E80	LRE363	63-80	160NHG000B	160	00	NX160	50
22	90	120	164	94.7	LC1E95	LC1E95	LC1E80	LRE365	80-104	200NHG1B	200	1	NX200	50
23	110	150	204	117.8	LC1E120	LC1E120	LC1E95	LRE482	84-135	250NHG1B	250	1	NX250	50
24	125	170	234	135.1	LC1E160	LC1E160	LC1E120	LRE483*	124-198	250NHG1B	250	1	NX250	50
25	132	180	247	142.6	LC1E160	LC1E160	LC1E120	LRE483*	124-198	250NHG1B	250	1	NX250	50
26	150	200	248	143.2	LC1E160	LC1E160	LC1E120	LRE483*	124-198	250NHG1B	250	1	NX250	50
27	160	215	288	166.3	LC1E200	LC1E200	LC1E160	LRE483	124-198	315NHG2B	300	2	NX315	50
28	180	240	298	172.1	LC1E200	LC1E200	LC1E160	LRE483	124-198	315NHG2B	300	2	NX315	50
29	200	270	348	200.9	LC1E250	LC1E250	LC1E160	LRE484	146-234	400NHG2B	400	2	NX400	50
30	225	300	360	207.9	LC1E250	LC1E250	LC1E160	LRE484	146-234	400NHG2B	400	2	NX400	50
31	250	335	435	251.2	LC1E300	LC1E300	LC1E200	LRE485	174-279	450NHG3B	450	3	NX630	50
32	275	370	440	254.0	LC1E300	LC1E300	LC1E200	LRE485	174-279	450NHG3B	450	3	NX630	50
33	315	425	548	316.4	LC1E400	LC1E400	LC1E250	LRE486	208-333	630NHG3B	630	3	NX630	50
34	335	452	580	334.9	LC1E400	LC1E400	LC1E250	LRE487	258-414	630NHG3B	630	3	NX630	50
35	355	475	618	356.8	LC1E400	LC1E400	LC1E250	LRE487	258-414	630NHG3B	630	3	NX630	50
36	375	502	653	377.0	LC1E400	LC1E400	LC1E250	LRE487	258-414	800NHG3B	800	3	NA	50
37	400	535	674	389.1	LC1E500	LC1E500	LC1E300	LRE487	258-414	800NHG3B	800	3	NA	200

* Relay can match with contactor electrically (i.e Cannot be directly mounted), rest all relays are suitable for direct mounting as per catalogue. Use alternate suggested for direct mounting.

**Selection valid upto Trip class 10/10A, Contact Customer Care for details of EOCR to be used with this selection charts.

Please use Star-Delta Timer.

Selection Chart

Direct-on-Line starters with circuit-breaker type CVS and overload protection by separate overload relay type LRE (thermal) or EOCR** (up to Trip class 10/10A)

Reliable
switching for
IE2/IE3 motors



IE2



IE3

Rated Operational Voltage, $U_e = 400/415V, 50/60Hz$
Short Circuit Current $I_q = 50kA$

Type-2 Recommended Selection

Sr. No.	3Φ Motors			Contactor	Overload Relay		Circuit Breaker			
	kW	HP	FLC - I_n (Amps)		Type	Range (A)	Type	Trip Unit Rating	Magnetic Setting Range	Setting on Trip Unit in Amps
1	0.37	0.5	1.4	LC1E09	LRE06	1-1.6	CVS100-MA	2.5	6-14	15
2	0.55	0.75	1.7	LC1E09	LRE07	1.6-2.5	CVS100-MA	2.5	6-14	17.5
3	0.75	1	2.2	LC1E09	LRE07	1.6-2.5	CVS100-MA	2.5	6-14	22.5
4	1.1	1.5	2.9	LC1E09	LRE08	2.5-4	CVS100-MA	6.3	6-14	31.5
5	1.3	1.75	3	LC1E09	LRE08	2.5-4	CVS100-MA	6.3	6-14	31.5
6	1.5	2	3.8	LC1E09	LRE08	2.5-4	CVS100-MA	6.3	6-14	37.8
7	2.2	3	5.1	LC1E18	LRE10	4-6	CVS100-MA	6.3	6-14	63
8	3	4	6	LC1E18	LRE10	4-6	CVS100-MA	6.3	6-14	69.3
9	3.7	5	8.1	LC1E25	LRE14	7-10	CVS100-MA	12.5	6-14	100
10	4	5.5	8.5	LC1E25	LRE14	7-10	CVS100-MA	12.5	6-14	100
11	5.5	7.5	11.4	LC1E32	LRE16	9-13	CVS100-MA	12.5	6-14	137.5
12	7.5	10	15.4	LC1E32	LRE21	12-18	CVS100-MA	25	6-14	175
13	9.3	12.5	17.3	LC1E32	LRE21	12-18	CVS100-MA	25	6-14	200
14	11	15	22	LC1E40B	LRE22	16-24	CVS100-MA	25	6-14	275
15	13	17.5	24	LC1E40B	LRE22	16-24	CVS100-MA	25	6-14	300
16	15	20	30	LC1E50	LRE32* or LRE353	23-32	CVS100-MA	50	6-14	350
17	18.5	25	36	LC1E65	LRE35* or LRE355	30-38* 30-40	CVS100-MA	50	6-14	450
18	22	30	43	LC1E65	LRE357	37-50	CVS100-MA	50	6-14	500
19	30	40	56	LC1E80	LRE359	48-65	CVS100-MA	100	6-14	700
20	37	50	69	LC1E95	LRE361	55-70	CVS100-MA	100	6-14	800
21	45	60	84	LC1E120	LRE482	84-135	CVS100-MA	100	6-14	1000
22	55	75	99	LC1E160	LRE482	84-135	CVS100-MA	100	6-14	1200
23	75	100	134	LC1E160	LRE482	84-135	CVS250-MA	150	9-14	1650
24	80	110	139	LC1E160	LRE483	124-198	CVS250-MA	150	9-14	1650
25	90	120	164	LC1E200	LRE483	124-198	CVS250-MA	220	9-14	1980
26	110	150	204	LC1E250	LRE484	146-234	CVS250-MA	220	9-14	2420
27	125	170	234	LC1E300	LRE484	146-234	CVS400-MA	320	6-13	2880
28	132	180	247	LC1E300	LRE485	174-279	CVS400-MA	320	6-13	3200
29	160	215	288	LC1E400	LRE486	208-333	CVS400-MA	320	6-13	3520
30	180	240	298	LC1E400	LRE486	208-333	CVS400-MA	320	6-13	3520
31	200	270	348	LC1E400	LRE487	258-414	CVS630-MA	500	6-13	4500
32	225	300	360	LC1E500	LRE487* or LRE488	258-414* 321-513	CVS630-MA	500	6-13	4500
33	250	335	435	LC1E500	LRE488	321-513	CVS630-MA	500	6-13	5500
34	275	370	440	LC1E630	LRE489	394-630	CVS630-MA	500	6-13	5500
35	315	425	548	LC1E630	LRE489	394-630	CVS630-ETS	630	2-10	6300
36	335	452	580	LC1E630	LRE489	394-630	CVS630-ETS	630	2-10	6300
37	355	475	618	LC1E630	LRE489	394-630	CVS800-TMD	800	3.5-10	8000

* Relay can match with contactor electrically (i.e Cannot be directly mounted), rest all relays are suitable for direct mounting as per catalogue. Use alternate suggested for direct mounting.

** Selection valid upto Trip class 10/10A, Contact Customer Care for details of EOCR to be used with this selection charts.

Selection Chart

Star Delta starters with circuit-breaker type CVS and overload protection by separate overload relay type LRE (thermal) or EOCR** (up to Trip class 10/10A)

Reliable switching for IE2/IE3 motors



IE2



IE3

Rated Operational Voltage, $U_e = 400/415V, 50/60Hz$
Short Circuit Current $I_q = 50kA$

Type-2 Recommended Selection

Sr. No.	3Φ Motors				Contactor			Overload Relay		Circuit Breaker				Minimum Pause time# (mSec)
	kW	HP	FLC - I_n (Amps)					Type	Range (A)	Type	Trip Unit Rating	Mag-netic Setting Range	Setting on Trip Unit in Amps	
			Line	Phase	Main	Delta	Star							
1	0.75	1	2.2	1.3	LC1E09	LC1E09	LC1E09	LRE06	1-1.6	CVS100-MA	6.3	6-14	37.8	50
2	1.1	1.5	2.9	1.7	LC1E09	LC1E09	LC1E09	LRE07	1.6-2.5	CVS100-MA	6.3	6-14	50.4	50
3	1.3	1.8	3	1.7	LC1E09	LC1E09	LC1E09	LRE07	1.6-2.5	CVS100-MA	6.3	6-14	50.4	50
4	1.5	2	3.8	2.2	LC1E09	LC1E09	LC1E09	LRE07	1.6-2.5	CVS100-MA	6.3	6-14	63	50
5	2.2	3	5.1	2.9	LC1E09	LC1E09	LC1E09	LRE08	2.5-4	CVS100-MA	12.5	6-14	100	50
6	3	4	6	3.5	LC1E09	LC1E09	LC1E09	LRE08	2.5-4	CVS100-MA	12.5	6-14	112.5	50
7	3.7	5	8.1	4.7	LC1E09	LC1E09	LC1E09	LRE10	4-6	CVS100-MA	12.5	6-14	150	50
8	4	5.5	8.5	4.9	LC1E09	LC1E09	LC1E09	LRE10	4-6	CVS100-MA	12.5	6-14	162.5	50
9	5.5	7.5	11.4	6.6	LC1E12	LC1E12	LC1E09	LRE12	5.5-8	CVS100-MA	25	6-14	225	50
10	7.5	10	15.4	8.9	LC1E18	LC1E18	LC1E09	LRE14	7-10	CVS100-MA	25	6-14	300	50
11	9.3	13	17.3	10	LC1E25	LC1E25	LC1E12	LRE14	7-10	CVS100-MA	25	6-14	325	50
12	11	15	22	12.7	LC1E25	LC1E25	LC1E12	LRE16	9-13	CVS100-MA	50	6-14	400	50
13	13	18	24	13.9	LC1E32	LC1E32	LC1E12	LRE21	12-18	CVS100-MA	50	6-14	450	50
14	15	20	30	17.3	LC1E32	LC1E32	LC1E18	LRE21	12-18	CVS100-MA	50	6-14	550	50
15	18.5	25	36	20.8	LC1E40B	LC1E40B	LC1E25	LRE22	16-24	CVS100-MA	50	6-14	700	50
16	22	30	43	24.8	LC1E40	LC1E40	LC1E32	LRE32* or LRE353	23-32	CVS100-MA	100	6-14	800	50
17	30	40	56	32.3	LC1E50	LC1E50	LC1E38	LRE355	30-40	CVS100-MA	100	6-14	1100	50
18	37	50	69	39.8	LC1E65	LC1E65	LC1E40	LRE355	30-40	CVS100-MA	100	6-14	1300	50
19	45	60	84	48.5	LC1E80	LC1E80	LC1E50	LRE357	37-50	CVS250-MA	150	9-14	1650	50
20	55	75	99	57.2	LC1E95	LC1E95	LC1E65	LRE359	48-65	CVS250-MA	150	9-14	1950	50
21	75	100	134	77.4	LC1E120	LC1E120	LC1E80	LRE481	62-99	CVS250-MA	220	9-14	2640	50
22	80	110	139	80.3	LC1E120	LC1E120	LC1E80	LRE481	62-99	CVS250-MA	220	9-14	2640	50
23	90	120	164	94.7	LC1E160	LC1E160	LC1E95	LRE482	84-135	CVS250-MA	220	9-14	3080	50
24	110	150	204	117.8	LC1E200	LC1E200	LC1E120	LRE482*	84-135	CVS400-MA	320	6-13	3840	50
25	125	170	234	135.1	LC1E250	LC1E250	LC1E120	LRE483*	124-198	CVS630-MA	500	6-13	4500	50
26	132	180	247	142.6	LC1E250	LC1E250	LC1E120	LRE483*	124-198	CVS630-MA	500	6-13	5000	50
27	150	200	248	143.2	LC1E250	LC1E250	LC1E120	LRE483*	124-198	CVS630-MA	500	6-13	5000	50
28	160	215	288	166.3	LC1E300	LC1E300	LC1E160	LRE483*	124-198	CVS630-MA	500	6-13	5500	50
29	180	240	298	172.1	LC1E300	LC1E300	LC1E160	LRE483*	124-198	CVS630-MA	500	6-13	6000	50
30	200	270	348	200.9	LC1E400	LC1E400	LC1E200	LRE484	146-234	CVS630-MA	500	6-13	6500	50
31	225	300	360	207.9	LC1E400	LC1E400	LC1E200	LRE484	146-234	CVS630-MA	500	6-13	6500	50
32	250	335	435	251.2	LC1E400	LC1E400	LC1E250	LRE485	174-279	CVS630-MA	500	6-13	6500	50
33	275	370	440	254	LC1E400	LC1E400	LC1E250	LRE485	174-279	CVS630-MA	500	6-13	6500	50
34	315	425	548	316.4	LC1E500	LC1E500	LC1E300	LRE486*	208-333	CV630-ETS	630	2-10	6300	200

* Relay can match with contactor electrically (i.e Cannot be directly mounted), rest all relays are suitable for direct mounting as per catalogue. Use alternate suggested for direct mounting.

**Selection valid upto Trip class 10/10A, Contact Customer Care for details of EOCR to be used with this selection charts.

Please use Star-Delta Timer.

Note

Lined writing area consisting of 20 horizontal lines.

Life Is 

Schneider
 Electric

Schneider Electric India Pvt. Ltd.

Corporate Office: 9th Floor, DLF Building No. 10, Tower C, DLF Cyber City, Phase II, Gurugram 122002 Haryana
Tel.: ++91 124 6899000 Fax: ++91 124 4222036/037

Ahmedabad

Schneider Electric India (P) Ltd.
1506-1507, 15th Floor Shapth-5
Opp.Karnavati Club, SG Highway,
Ahmedabad, Gujarat - 380015
Tel.: 079-66826701

Coimbatore

Schneider Electric India (P) Ltd.
Hanudev Info Tech Park, 6th Floor
Unit No. Block-C, SF No. 558/2
Udalyampalayam Road, Nava India
Coimbatore-641028

Lucknow

Schneider Electric India (P) Ltd.
Summit, Plot No. TCG 3/3
6th Floor, 604A/B/C, Vibhuti Khand
Gomti Nagar, Lucknow
Uttar Pradesh - 226010
Tel.: 0522-3500334

Nashik

Schneider Electric India (P) Ltd.
401, 4th Floor, Rishi Raj Towers
Jehan Circle, Gangapur Road
Nashik- 422013
Tel.: 0253-2344333

Bengaluru

Schneider Electric India (P) Ltd.
No. 3/1, JP Techno Park
Mezzanine Floor, Millers Tank Bund
Road, Vasanth Nagar
Bengaluru - 560052
Tel.: 080-71481351

Hyderabad

Schneider Electric India (P) Ltd.
D.No. 1-8-271, # 401, Ashoka
Bhoopal Chambers, SP Road
Secunderabad - 500003
Tel.: 040-67219500

Ludhiana

Schneider Electric India (P) Ltd.
SCO 23, 2nd Floor,
Chandigarh Road, Sector 32
Ludhiana, Punjab-141010
Tel.: 0161- 5203011

New Delhi

Schneider Electric India (P) Ltd.
C-56, Mayapuri Industrial Area, Phase-2
New Delhi - 110064
Tel.: 011-61317400

Bhubaneswar

Schneider Electric India (P) Ltd.
Workloop Co-Working in the property
Office No. 316, Esplanade One Mall
Rasulgarh, Bhubaneswar - 751010

Indore

Schneider Electric India (P) Ltd.
219, Dhan Trident Building
Vijay Nagar, A.B.Road
Indore-452001

Mohali

Schneider Electric India (P) Ltd.
2nd Floor, Tower-A
Bestech Business Tower
Mega Information & Technology Park
Industrial Plot No.1, Phase IX
(Expansion), Mohali- 160059
Tel.: 0172-7198200

Pune

Schneider Electric India (P) Ltd.
Amar Caliber, CTS No 911, BMCC Road,
OFF FC. Road, Deccan Gymkhana,
Shivaji Nagar, Pune - 411007
Tel.: 020-67492500

Chennai

Schneider Electric India (P) Ltd.
No: 29, 2nd Floor,
Bannari Amman Towers, B-Block
Dr. Radhakrishnan Road, Mylapore
Chennai - 600 004
Tel.:044-71912000

Jaipur

Schneider Electric India (P) Ltd.
Jaipur Business Centre 309
3rd Floor, Sangam Tower 190
Church Road, Jaipur-302001
Tel.: 0141-2374810

Mumbai

Schneider Electric India (P)(Ltd)
Marwah House, 2nd Floor
Krishanlal Marwah Marg
Andheri (East), Mumbai - 400072
Tel.: 022-62280000

Vadodara

Schneider Electric India (P) Ltd.
Notus IT Park, 10th Floor, Block-D
Sarabhai Campus, Vadiwadi
Vadodara, Gujarat - 390017

Cochin

Schneider Electric India (P) Ltd.
Alapatt Properties Private Limited
(Trade Name : Centre A)
Main Door Number : 66/4971
(Old Door Number: 40/6584-H)
7th Floor Alapatt Heritage Building
MG Road Kochi - 682035

Kolkata

Schneider Electric (I)Pvt.Ltd,
BP-4, Sector-V, Technopolis
3rd Floor, Salt Lake City
Kolkata- 700 091
Tel.: 033-66576400

Nagpur

Schneider Electric India (P) Ltd.
6, Vasant Vihar Complex
W.H.C Road, Shankar Nagar
Nagpur- 440010
Tel.: 0712-2558581

Vishakhapatnam

Schneider Electric India (P) Ltd.
D.N.10-1-43, 1st Floor
Ratnam's Business Centre,
Siripuram Fort, C.B.M.Compound
Visakhapatnam - 530016
Tel.: 0891-6675500

Customer Care Centre

Monday-Saturday, 9 a.m. to 8 p.m.

Toll-free numbers: 1800 419 4272, 1800 103 0011

Email: customercare.in@schneider-electric.com

For more information, visit our website at: www.se.com/in

- All Prices are in Indian Rupees
- Prices are subject to change without prior notice
- Product evolution is a continuous process and Schneider Electric reserves the right to modify/withdraw any product at any time without prior notice
- Prices charged will be as prevailing on the date of dispatch
- Invoice Amount = (MRP – less Applicable discount) + Applicable GST %
- Tax incidence on invoices is basis applicable GST rates
- Invoice amount not to exceed MRP
- Product pictures shown are for illustration purpose only, actual product may vary

Distributor