



Life Is On

Schneider
Electric

 **BALAJI SWITCHGEARS**

Final Distribution & Wiring Devices

Maximum Retail Price Effective January 17th 2024

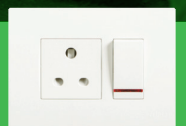

se.com/in

The Global Specialist in energy management and automation

Schneider electric is the global specialist in energy management and automation .With revenues of 29 billion Euros in FY2021, Our 140000+ employees serve customers in over 100 countries ,helping them manage their energy and processes in ways that are safe, reliable, efficient and sustainable. Schneider Electric offers integrated solutions across multiple market segments, including leadership positions in energy and infrastructure, industrial processes, building automation and data centres/networks, as well as a broad presence in residential applications. The Installation Systems & Control Division of Schneider Electric provides solutions that represent the best in lifestyle and innovation for offices, hotels and homes. These solutions include award-winning products in the areas of building and home automation, designer switches and sockets. They help the finest architects around the world to achieve more with less.

Schneider Electric Global footprint



Schneider Electric India footprint

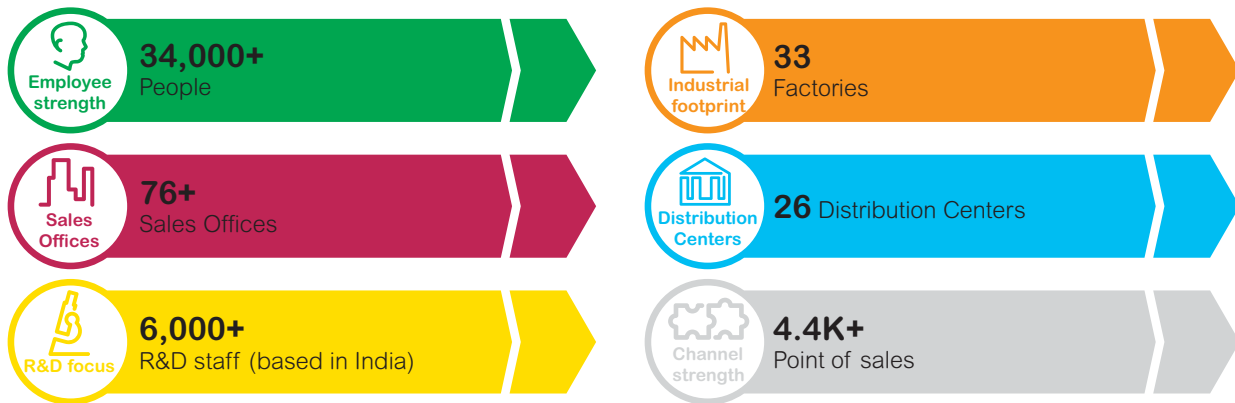

Our business offerings

Span the entire spectrum from Plant-to-Plug.

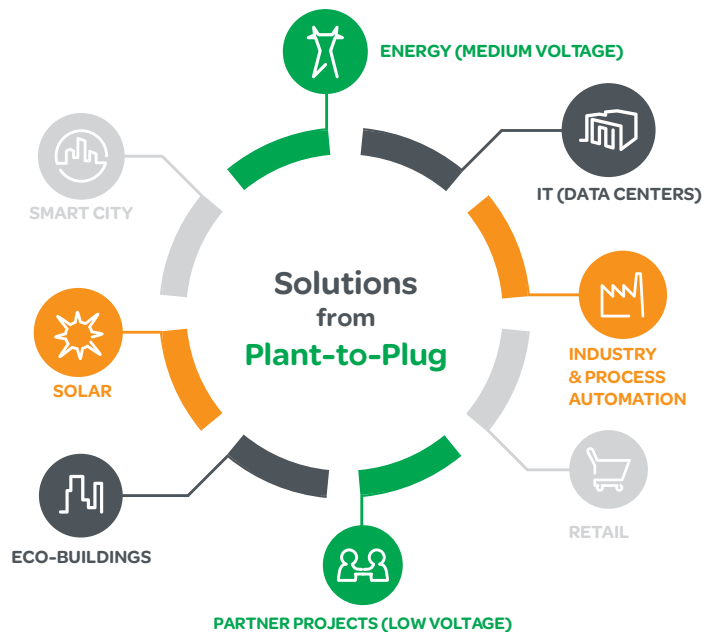

Easy9 Philosophy

Easy on eyes



Easy on mind



Easy to sell

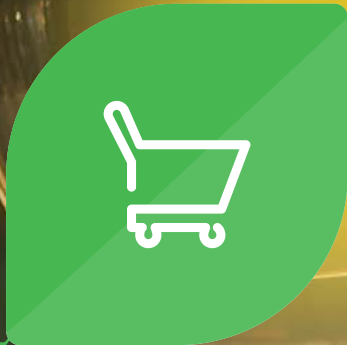

Easy to install



Miniature Circuit Breaker (MCB)

For circuit protection against Overload and Short Circuit Current Fault

- CE Marked as per IS/IEC 60898 -1
- Breaking Capacity 6kA** and 10kA
- Green Compliance: RoHS, REACh, EoLI, PEP
- Energy Limiting Class 3
- Trip Free Mechanism
- Fast Tripping
- Suitable for Positive Isolation
- Line Load Reversibility
- Laser Printing
- Bi-connect Terminals
- Degree of Protection IP 20
- Operating Voltage 240V / 415V
- Frequency 50Hz

Easy9 - C Curve 6kA



[In] Rated Current (A)	1 Pole Reference	Unit MRP [₹]	2 Pole Reference	Unit MRP [₹]	3 Pole Reference	Unit MRP [₹]	4 Pole Reference	Unit MRP [₹]
Module Width**	1 mod		2 mod		3 mod		4 mod	
Package Size	12 Nos.		6 Nos.		4 Nos.		3 Nos.	
6	EZ9F76106	233	EZ9F76206	877	EZ9F76306	1361	-	-
10	EZ9F76110	233	EZ9F76210	877	EZ9F76310	1361	-	-
16	EZ9F76116	233	EZ9F76216	877	EZ9F76316	1361	EZ9F76416	1935
20	EZ9F76120	233	EZ9F76220	877	EZ9F76320	1361	EZ9F76420	1935
25	EZ9F76125	233	EZ9F76225	877	EZ9F76325	1361	EZ9F76425	1935
32	EZ9F76132	233	EZ9F76232	877	EZ9F76332	1361	EZ9F76432	1935
40	EZ9F76140	538	EZ9F76240	1165	EZ9F76340	1970	EZ9F76440	2637

Easy9 - B Curve 10kA

[In] Rated Current (A)	1 Pole Reference	Unit MRP [₹]	2 Pole Reference	Unit MRP [₹]	3 Pole Reference	Unit MRP [₹]	4 Pole Reference	Unit MRP [₹]
Module Width**	1 mod		2 mod		3 mod		4 mod	
Package Size	12 Nos.		6 Nos.		4 Nos.		3 Nos.	
6	EZ9F21106	281	-	-	-	-	-	-
10	EZ9F21110	281	-	-	-	-	-	-
16	EZ9F21116	281	-	-	-	-	-	-
20	EZ9F21120	281	-	-	-	-	-	-
25	EZ9F21125	281	-	-	-	-	-	-
32	EZ9F21132	281	EZ9F21232	1055	-	-	-	-
40	-	-	EZ9F21240	1523	-	-	-	-
63	-	-	EZ9F21263	1770	-	-	EZ9F21463	3215

Easy9 - C Curve 10kA

[In] Rated Current (A)	1 Pole Reference	Unit MRP [₹]	2 Pole Reference	Unit MRP [₹]	3 Pole Reference	Unit MRP [₹]	4 Pole Reference	Unit MRP [₹]
Module Width**	1 mod		2 mod		3 mod		4 mod	
Package Size	12 Nos.		6 Nos.		4 Nos.		3 Nos.	
6	EZ9F71106	306	-	-	EZ9F71306	1686	-	-
10	EZ9F71110	306	EZ9F71210	1059	EZ9F71310	1686	-	-
16	EZ9F71116	306	EZ9F71216	1059	EZ9F71316	1686	EZ9F71416	2311
20	EZ9F71120	306	EZ9F71220	1059	EZ9F71320	1686	EZ9F71420	2311
25	EZ9F71125	306	EZ9F71225	1059	EZ9F71325	1686	EZ9F71425	2311
32	EZ9F71132	306	EZ9F71232	1059	EZ9F71332	1686	EZ9F71432	2311
40	-	-	EZ9F71240	1556	EZ9F71340	2441	EZ9F71440	2980
63	EZ9F71163	802	EZ9F71263	1745	EZ9F71363	2589	EZ9F71463	3163

Note: Please contact nearest Schneider Electric Sales Office or Customer Care Center for Stockable and Non Stockable status of references

* Price on Request

**18mm/module

Residual Current Circuit Breaker (RCCB) - AC Type

- ISI/CE Marked as per IS/IEC 61008-1
- Green Compliance: RoHS, REACH, EoLI, PEP
- Voltage Independent RCCB
- Suitable for Positive Isolation
- Laser Printing
- Bi-connect Terminal
- Degree of Protection IP 20
- Operating Voltage 240V / 415V
- Frequency 50Hz



[In] Rated Current (A)	Earth Leakage Sensitivity (mA)	2 Pole Reference	Unit MRP [₹]	4 Pole Reference	Unit MRP [₹]
Module Width**		2 Mod		4 Mod	
Package Size		6		3	
25	30	EZ9R35225	3441	EZ9R35425	4663
	100	EZ9R55225	3654	EZ9R55425	4748
	300	EZ9R65225	3724	EZ9R65425	4840
40	30	EZ9R35240	3570	EZ9R35440	4583
	100	EZ9R55240	3825	EZ9R55440	4840
	300	EZ9R65240	3793	EZ9R65440	4845
63	30	EZ9R35263	4779	EZ9R35463	4822
	100	EZ9R55263	5016	EZ9R55463	5162
	300	EZ9R65263	4963	EZ9R65463	5118

Note: Please contact nearest Schneider Electric Sales Office or Customer Care Center for Stockable and Non Stockable status of references

* Price on Request

**18mm/module

Isolator

- CE Marked, AC - 22A, Conforms to IEC 60947-3
- Green Compliance: RoHS, REACH, EoLI, PEP
- Suitable for Positive Isolation
- Line Load Reversibility
- Laser Printing
- Bi-connect Terminals
- Degree of Protection IP 20
- Operating Voltage 240V / 415V
- Frequency 50Hz



[In] Rated Current (A)	2 Pole Reference	Unit MRP [₹]	3 Pole Reference	Unit MRP [₹]	4 Pole Reference	Unit MRP [₹]	
Module Width**		2		3 Mod		4 Mod	
Package Size		6		4		3	
40	EZ9S66240	577	EZ9S66340	1226	EZ9S66440	1378	
63	EZ9S66263	769	EZ9S66363	2040	EZ9S66463	1403	
80	-	-	-	-	EZ9S66480	1880	

Note: Please contact nearest Schneider Electric Sales Office or Customer Care Center for Stockable and Non Stockable status of references

* Price on Request

**18mm/module

Please contact Customer Care Center for Stockable and Non stockable status of references.

NORMAL STOCK ITEMS

W.E.F. January 17th, 2024

Timers & Time Switches

Analog Time Switches



- 24H, 7D Programmable switch Voltage Rating: 230V AC +10%, -15%
- Memory: Upto 56 Switching Operations
- Back up of program: Operating reserve for 100, 200 Hours
- Overall dimensions: 5 modules
- Minimum time between two switching operations: 15, 30 min
- Accuracy: $\leq \pm 1$ s/day at +20°C

Description	Module Width 18mm/module	Reference	Unit MRP [₹]
IH 24H 16 A 15 mts interval 1 channel	1	15336	5694
IH 24H 16 A 30 mts interval 1 channel	1	CCT15365	6211
IH 7 day 16 A 1 channel- Max 21 On and 21 Off cycles	3	CCT15367	8891
IH 24H 16 A 30 mts 1 channel without reserve	3	CCT16364	5045

Digital Time Switches



- 7D, 24H Programmable switch. Voltage Rating: 230V AC +10%, -15%
- Consumption: 1 channel - max. 4VA; 2 channels - max. 7VA
- Memory: Upto 56 Switching Operations
- Back up of program & time by lithium battery: Operating reserve: 6 Years
- Overall dimensions: 5 modules
- Cable length: 100m
- Minimum time between two switching operations: 1 min

Description	Module Width 18mm/module	Reference	Unit MRP [₹]
IHP 1C w (24h/7d) programmable time switch	2.5	CCT15441	12239
IHP+ 1C (24h/7d) SMARTw programmable time switch	2.5	CCT15551	15099
IHP 2C w (24h/7d) programmable time switch	2.5	CCT15443	15788
IHP DCF (24h/7d) SMART programmable time switch	2.5	CCT15858	24853
IHP+ 2C (24h/7d) SMARTw programmable time switch	2.5	CCT15553	17468

Timers



- Switching capacity 16 A, max
- Delay range from 30 sec to 20 min
- Capacity for lighted pushbutton 150 mA
- Electric distribution busbar compatibility
- Output power capacity CCT15232-2300W
- Output power capacity CCT15223-3600W

Description	Module Width 18mm/module	Reference	Unit MRP [₹]
MINs - electronic timer - 0.5 to 20 min	1	CCT15232	6913
MINs - electronic timer - 0.5 to 20 min with switch Off Warning	1	CCT15233	8878
MINs - electronic timer - 0.5 to 20 min with switch Off Warning and Impulse relay function	1	CCT15234	8345

Please contact Customer Care Center for Stockable and Non stockable status of references.

NORMAL STOCK ITEMS

W.E.F. January 17th, 2024

Twilight switch



- Includes wall mounted cell
- Adjustable brightness threshold 2 to 2000 Lux
- 2 LEDs to signal the sensor status and the output status
- Test button: To check the product and load cabling
- Switching capacity: 16Amp
- Screwless Terminals compatible with rigid and flexible wires
- Consumption 6 VA
- Size 45mm

Description	Module Width 18mm/module	Reference	Unit MRP [₹]
IC2000 outdoor (2 - 2000 lux) twilight switch	1	CCT15369	14581
Analogue indoor light sensor cell	-	CCT15262	7195
Wall mounted Analogue outdoor light sensor cell	-	CCT15263	11152
IC100 (2 - 100 lux) twilight switch	1	CCT15482	12266
IC2000 indoor (2 - 2000 lux) twilight switch	1	CCT15285	10931
IC2000p+ (2 - 2000 lux) programmable twilight switch	2.5	CCT15483	25336
IC100kp+ 1C (1 - 99000 lux) SMART programmable twilight switch	2.5	CCT15494	30643
IC100kp+ 2C (1 - 99000 lux) SMART programmable twilight switch	2.5	CCT15495	37724
IC Astro 2C SMART programmable twilight switch	2.5	CCT15245	26484
IC Astro 1C SMART programmable twilight switch	2.5	CCT15225	22285

Time switch accessories

Description	Module Width 18mm/module	Reference	Unit MRP [₹]
Programming kit for IHP / IC	1	CCT15860	11657

Thermostat

Description	Module Width 18mm/module	Reference	Unit MRP [₹]
THP1+ 1C (24h/7d) programmable thermostat	2.5	CCT15834	26516

Note: Please contact nearest Schneider Electric Sales Office or Customer Care Center for Stockable and Non Stockable status of references

* Price on Request

**18mm/module

Easy9 Distribution Boards



IK-08
tested

IP-30
Single door
IP-43
Double door



Features

- Clean and attractive colour and finish (White RAL 9003)
- Unique design of door knob for easy operation
- IP compliant to IS 8623
- High quality powder coating for long life and high reliability under the toughest of conditions
- Optimized wiring space for a clean installation
- Suitable for surface and flush mounting
- Cement Spill protector helps avoid entry of dust and cement particles
- Reversible door
- Independent centre plate
- 45° angled hole for easy installation and 1 key hole for easy alignment
- Removable top and bottom gland plates
- Unique 5-hole mounting for single-person fixing
- Simple 3-piece design for quick assembly
- Combi-head screws for tool flexibility

Easy9 Distribution Boards

Metal Enclosures



Description	Module Cutout Width**	Single Door (IP30) Reference	Unit MRP [₹]
2 way Enclosure	2	EZ9EMES02	633
4 way Enclosure	4	EZ9EMES04	714

Metal Clad P&S Units



Description	Module Cutout Width**	Single Door (IP30) Reference	Unit MRP [₹]
EZ9 Metal P&S Unit 20A 1P+N+E	2	EZ9EMS220	2051
EZ9 Metal P&S Unit 30A 3P+E	3	EZ9EMS330	4696

Phase Selector DBs



Description	Module Cutout Width**	Double Door (IP43) Reference	Unit MRP [₹]
Easy9 DB 4Way phase selector vertical	8 + 4 x 3	EZ9EPVD04N	8276
Easy9 DB 6Way phase selector vertical	8 + 6 x 3	EZ9EPVD06N	8816
Easy9 DB 8Way phase selector vertical	8 + 8 x 3	EZ9EPVD08N	9517

Phase Selector Switch



Description	Reference	Unit MRP [₹]
Easy9 DB 40A selector switch	EZ9EPS40SN	7534
Easy9 DB 63A selector switch	EZ9EPS63SN	8816

SPN DBs



Description	Total Module Cutout Width** (Incomer + Outgoing)**	Single Door (IP30) Reference	Unit MRP [₹]	Double Door Metal (IP43) Reference	Unit MRP [₹]
Easy9 SPN DB 4 way	2 + 2	-	-	EZ9ESND04	2044
Easy9 SPN DB 6 way	2 + 4	-	-	EZ9ESND06	2119
Easy9 SPN DB 8 way	2 + 6	EZ9ESNS08	1518	EZ9ESND08	2324
Easy9 SPN DB 10 way	2 + 8	-	-	EZ9ESND10	2522
Easy9 SPN DB 12 way	2 + 10	-	-	EZ9ESND12	2771
Easy9 SPN DB 16 way	2 + 14	-	-	EZ9ESND16	4083

Please contact Customer Care Center for Stockable and Non stockable status of references.

NORMAL STOCK ITEMS

W.E.F. January 17th, 2024

Easy9 Distribution Boards

TPN DBs



Description	Total Module Cutout Width** (Incomer + Outgoing)	Single Door (IP30) Reference	Unit MRP [₹]	Double Door Metal (IP43) Reference	Unit MRP [₹]
Easy9 TPN DB 4 way - 4 Mod Incomer	4 + 4 x 3	-	-	EZ9ETND04E	4113
Easy9 TPN DB 4 way	8 + 4 x 3	-	-	EZ9ETND04	4747
Easy9 TPN DB 6 way	8 + 6 x 3	-	-	EZ9ETND06	5915
Easy9 TPN DB 8 way	8 + 8 x 3	-	-	EZ9ETND08	7467
Easy9 TPN DB 12 way	8 + 12 x 3	-	-	EZ9ETND12	11436

VTPN DBs Modular Incomer



Description	Total Module Cutout Width** (Incomer + Outgoing)	Double Door Metal (IP43) Reference	Unit MRP [₹]
Easy9 VTPN DB 4 Ways Modular i/c	12+12	EZ9EVM04	Coming Soon
Easy9 VTPN DB 8 Ways Modular i/c	12+24	EZ9EVM08	
Easy9 VTPN DB 12 Ways Modular i/c	12+36	EZ9EVM12	

VTPN DBs MCCB Incomer



Description	Total Module Cutout Width** (Incomer + Outgoing)	Double Door Metal (IP43) Reference	Unit MRP [₹]
Easy9 VTPN DB 4 Ways CVS i-c 100A	100A MCCB+ 12	EZ9EVN04L	Coming Soon
Easy9 VTPN DB 8 Ways CVS i-c 100A	100A MCCB+ 24	EZ9EVN08L	
Easy9 VTPN DB 12 Ways CVS i-c 100A	100A MCCB+ 36	EZ9EVN12L	
Easy9 VTPN DB 4 Ways CVS i/c 160A	160A MCCB+ 12	EZ9EVN04M	
Easy9 VTPN DB 8 Ways CVS i/c 160A	160A MCCB+ 24	EZ9EVN08M	
Easy9 VTPN DB 12 Ways CVS i/c 160A	160A MCCB+ 36	EZ9EVN12M	
Easy9 VTPN DB 8 Ways CVS i/c 250A	250A MCCB+ 24	EZ9EVN08H	
Easy9 VTPN DB 12 Ways CVS i/c 250A	250A MCCB+ 36	EZ9EVN12H	

Please contact Customer Care Center for Stockable and Non stockable status of references.

NORMAL STOCK ITEMS

W.E.F. January 17th, 2024

Wander Plugs



- Conforms to IEC 60309-1 & IEC 60309-2
- PK PratiKa Screw Connect: same orientation of clamp's screws
- External impact strength: IK08
- Glow wire test: 850°C

[In] Rated Current (A)	[Ue] Rated Operational Voltage (V)	Poles Description	Reference	Unit MRP [₹]
PratiKa Screw				
IP44				
16	200...250	2P + E	PKE16M423 <input checked="" type="checkbox"/>	607
		2P + E	PKX16M423 <input type="checkbox"/>	1,226
	380...415	3P + E	PKE16M434 <input checked="" type="checkbox"/>	768
		3P + N + E	PKE16M435 <input checked="" type="checkbox"/>	800
32	200...250	2P + E	PKE32M423 <input checked="" type="checkbox"/>	954
		3P + E	PKE32M434 <input checked="" type="checkbox"/>	1108
	380...415	3P + N + E	PKE32M435 <input checked="" type="checkbox"/>	1,092
		IP67		
16	200...250	2P + E	PKE16M723 <input checked="" type="checkbox"/>	1,325
		2P + E	PKX16M723 <input type="checkbox"/>	1,950
	380...415	3P + E	PKE16M734 <input checked="" type="checkbox"/>	1,497
		3P + N + E	PKE16M735 <input checked="" type="checkbox"/>	1,600
32	200...250	2P + E	PKE32M723 <input checked="" type="checkbox"/>	1,875
		3P + E	PKE32M734 <input checked="" type="checkbox"/>	2,023
	380...415	3P + N + E	PKE32M735 <input checked="" type="checkbox"/>	2,038
		PK (63A & 125A available in IP67 only)		
63	200...250	2P + E	81378	5,316
		3P + E	81382 <input checked="" type="checkbox"/>	5,068
	380...415	3P + N + E	81383 <input checked="" type="checkbox"/>	5,076
125	380...415	3P + E	81394	15,503
		3P + N + E	81395	15,503

Note: * Fast Connection

Small Wall Mounted Sockets



- Conforms to IEC 60309-1 & IEC 60309-2
- External impact strength: IK08
- Glow wire test: 850°C

[In] Rated Current (A)	[Ue] Rated Operational Voltage (V)	Poles Description	Reference	Unit MRP [₹]
IP44				
16	200...250	2P + E	PKF16W423	1062
		3P + E	PKF16W434	1232
	380...415	3P + N + E	PKF16W435	1346
32	200...250	2P + E	PKF32W423	1388
		3P + E	PKF32W434	1666
	380...415	3P + N + E	PKF32W435	1759
IP67				
16	200...250	2P + E	PKF16W723	1687
		3P + E	PKF16W734	2119
	380...415	3P + N + E	PKF16W735	2191
32	200...250	2P + E	PKF32W723	2111
		3P + E	PKF32W734	3083
	380...415	3P + N + E	PKF32W735	4089

Note: For all above Reference MOQ = 1

Please contact Customer Care Center for Stockable and Non stockable status of references.

NORMAL STOCK ITEMS

W.E.F. January 17th, 2024

Wall Mounted Sockets



81178



81183

- Conforms to IEC 60309-1 & IEC 60309-2
- Rated operational voltage upto 415V
- Rated operational current upto 125A
- External impact strength: IK08
- Glow wire test: 850°C
- Available only in IP67

[In] Rated Current (A)	[Ue] Rated Operational Voltage (V)	Poles Description	Reference	Unit MRP [₹]
63	200...250	2P + E	81178	6549
		3P + E	81182 ●	6740
	380...415	3P + N + E	81183	6837
125	380...415	3P + E	81194	23618
		3P + N + E	81195	23733

Wander Sockets



PKF16M423



81483



PKF32M735

- PK PratiKa Screw Connect: same orientation of clamp's screws.
- PK PratiKa: 16A & 32A; IP44 & IP67
- External impact strength: IK08
- Glow wire test: 850 °C
- Conforms to IEC 60309-1 & IEC 60309-2

[In] Rated Current (A)	[Ue] Rated Operational Voltage (V)	Poles Description	Reference	Unit MRP [₹]
PratiKa Screw				
IP44				
16	200...250	2P + E	PKF16M423 ✓	840
		2P + E	PKY16M423	926
	380...415	3P + E	PKF16M434	969
		3P + N + E	PKF16M435	1057
32	200...250	2P + E	PKF32M423 ✓	1155
		3P + E	PKF32M434	1402
	380...415	3P + N + E	PKF32M435 ✓	1411
IP67				
16	200...250	2P + E	PKF16M723	1555
		2P + E	PKY16M723 ●	1892
	380...415	3P + E	PKF16M734	1950
		3P + N + E	PKF16M735	2038
32	380...415	2P + E	PKF32M723	2139
		3P + E	PKF32M734	2367
	3P + N + E	PKF32M735	2389	
PK (63A & 125A available in IP67 only)				
63	200...250	2P + E	81478	5790
		3P + E	81482	5841
	380...415	3P + N + E	81483	5936
125	380...415	3P + E	81494	18278
		3P + N + E	81495	18636

Also Available on Request:

- Patented FAST connect Plugs & Sockets - innovative cabling system that enables connection without stripping the conductor and with absolutely no screws required
- Extra Low Voltage Plugs & Sockets down to 50V

Please contact nearest Schneider Electric Sales Office or Customer Care for Reference and Prices

Note: For all above Reference MOQ = 1

Please contact Customer Care Center for Stockable and Non stockable status of references.

✓ NORMAL STOCK ITEMS

W.E.F. January 17th, 2024

Panel Mounted Sockets - Angled



- PK PratiKa Screw Connect: same orientation of clamp's screws
- External impact strength: IK08
- Glow wire test: 850°C
- Conforms to IEC 60309-1 & IEC309-2

[In] Rated Current (A)	[Ue] Rated Operational Voltage (V)	Poles Description	Reference	Unit MRP [₹]
PratiKa Screw				
IP44				
16	200...250	2P + E	PKF16F423 <input checked="" type="checkbox"/>	650
		2P + E	PKY16F423 <input type="checkbox"/>	701
	380...415	3P + E	PKF16F434	969
		3P + N + E	PKF16F435 <input checked="" type="checkbox"/>	1033
32	200...250	2P + E	PKF32F423 <input checked="" type="checkbox"/>	1155
	380...415	3P + E	PKF32F434	1340
		3P + N + E	PKF32F435	1335
IP67				
16	200...250	2P + E	PKF16F723 <input checked="" type="checkbox"/>	1224
	380...415	2P + E	PKY16F723 <input type="checkbox"/>	1483
		3P + E	PKF16F734	1394
32	200...250	3P + N + E	PKF16F735 <input checked="" type="checkbox"/>	1411
	380...415	2P + E	PKF32F723	1593
		3P + E	PKF32F734	1862
		3P + N + E	PKF32F735	1892
PK (63A & 125A available in IP67 only)				
63	200...250	2P + E	81278	5228
	380...415	3P + E	81282 <input checked="" type="checkbox"/>	5236
		3P + N + E	81283 <input checked="" type="checkbox"/>	5339
125	380...415	3P + E	81294	17637
		3P + N + E	81295	17723

Panel Mounted Sockets - Straight



- PK PratiKa Screw Connect: same orientation of clamp's screws
- External impact strength: IK08
- Glow wire test: 850°C
- Conforms to IEC 60309-1 & IEC309-2

[In] Rated Current (A)	[Ue] Rated Operational Voltage (V)	Poles Description	Reference	Unit MRP [₹]
PratiKa Screw				
IP44				
16	200...250	2P + E	PKF16G423	736
		2P + E	PKY16G423 <input type="checkbox"/>	1091
	380...415	3P + E	PKF16G434	1284
		3P + N + E	PKF16G435 <input checked="" type="checkbox"/>	1108
32	200...250	2P + E	PKF32G423	1169
	380...415	3P + E	PKF32G434	1346
		3P + N + E	PKF32G435	1458
IP67				
16	200...250	2P + E	PKF16G723	1232
	380...415	2P + E	PKY16G723 <input type="checkbox"/>	1388
		3P + E	PKF16G734	1694
32	200...250	3P + N + E	PKF16G735 <input checked="" type="checkbox"/>	1411
		2P + E	PKF32G723	1571
	380...415	3P + E	PKF32G734	1768
		3P + N + E	PKF32G735	1834
PK (63A & 125A available in IP67 only)				
63	380...415	3P + E	81682	5288
125		3P + N + E	81683 <input checked="" type="checkbox"/>	5288
		3P + N + E	81695	17723

*Fast Connection

Note: For all above Reference MOQ = 1

Please contact Customer Care Center for Stockable and Non stockable status of references.

NORMAL STOCK ITEMS

W.E.F. January 17th, 2024

Sockets with Interlock Switches - for guaranteed safety of operation

- Allows closure of main switch only when the plug is fully inserted in socket - when complete mechanical & electrical connection has occurred
- Plug removal is possible only when the switch is in "off" position

Wall Mounted Sockets with Interlock Switch Unika (w/o protection)



83047

83081

- Switch designed for use in AC 22A class applications
- Conforms to IEC 60309-1 & IEC 60309-2
- Rated operational voltage upto 415V
- Rated operational current upto 32A
- External impact strength: IK08
- Available in IP44 / IP65 versions
- Glow wire test: 750°C

[In] Rated Current (A)	[Ue] Rated Operational Voltage (V)	Poles Description	Reference	Unit MRP [₹]
IP44				
16	200...250	2P + E	83031	8837
	380...415	3P + N + E	83036	12472
32	200...250	2P + E	83042 <input checked="" type="checkbox"/>	11472
	380...415	3P + E	83046	18569
		3P + N + E	83047	13519
IP65				
16	200...250	2P + E	83081	9143
	380...415	3P + E	83085	12591
		3P + N + E	83086	12847
32	200...250	2P + E	83092	11983
	380...415	3P + N + E	83097	14388

Socket with Interlock Switch & DIN Rail Isoblock (4.5 modules)



82754

83796

- Switch designed for use in AC- 22A class applications
- Conforms to IEC 60309-1 & IEC 60309-2
- Provision to DIN mount 4.5 module device
- External impact strength: IK10
- Available in IP65 version
- Glow wire test: 850°C

[In] Rated Current (A)	[Ue] Rated Operational Voltage (V)	Poles Description	Reference	Unit MRP [₹]
16	200...250	2P + E	82754 <input checked="" type="checkbox"/>	10955
	380...415	3P + N + E	82759	16752
32	200...250	2P + E	83791 <input checked="" type="checkbox"/>	12970
	380...415	3P + E	83795	18651
		3P + N + E	83796	15452

Socket with Interlock Switch & DIN Rail Isoblock (6 modules)



82766

- Switch designed for use in AC- 22A class applications
- Conforms to IEC 60309-1 & IEC 60309-2
- Provision to DIN mount 6 module device
- External impact strength: IK10
- Available in IP65 version
- Glow wire test: 850°C

[In] Rated Current (A)	[Ue] Rated Operational Voltage (V)	Poles Description	Reference	Unit MRP [₹]
32	200...250	2P + E	82766	17,110
63	380...415	3P + E	82782	23,055
		3P + N + E	82783	23,128

Note: For all above Reference MOQ = 1

Please contact Customer Care Center for Stockable and Non stockable status of references.

NORMAL STOCK ITEMS

W.E.F. January 17th, 2024

ELECTRA Metal Clad Plugs & Sockets are specially designed incorporating the latest safety, quality and user friendly features.

Construction

- The casting is made from non-corroding die-cast aluminum alloy combining exceptional compactness with high strength
- The design/construction eliminates the possibility of mismatch in fitting of plugs in corresponding sockets
- The floating contacts in the sockets are self aligning and facilitates smooth plugging in without undue pressure (These can be easily removed for wiring)
- A provision for pilot pin facilitates mechanical interlocking in case of 63A ratings

Human Safety

Specially designed shroud to avoid accidental finger contact with plug-pins while inserting/removing the plug
Similarly, the contact tubes in sockets are deeply recessed to avoid human contact

- The earthing pins ensure that earth connection is made first and broken last, being longer than conducting pins
- The visible earth terminals facilitate easy checking of earth connection
- The cable grip to the plug is made very strong by providing a compression gland and by protecting it at the point of entry by a strong rubber guard

Applications

Industrial, Commercial & Domestic portable equipments like Hand/Power Tools, Industrial Ovens, Welding Sets, Mobile Generators, Furnaces, Ships, Office Machines, Refrigerators, Coolers, Air-Conditioners, Overhead Cranes, Chilling Cabinets, Tile Polishers and Sewing Machines

Plug



Rating (A)	Poles Description	Voltage (V)	MOQ	Reference	Unit MRP [₹]
10	2P	250	30	AP10 <input checked="" type="checkbox"/>	283
20	2P	250	30	AP20 <input checked="" type="checkbox"/>	298
20	3P	440	30	BP20 <input checked="" type="checkbox"/>	396
30	3P	440	20	BP30 <input checked="" type="checkbox"/>	721
63	3P+N+E	440	4	CP63 <input checked="" type="checkbox"/>	3261

Socket



Rating (A)	Poles Description	Voltage (V)	MOQ	Reference	Unit MRP [₹]
10	2P	250	30	AS10 <input checked="" type="checkbox"/>	298
20	2P	250	30	AS20 <input checked="" type="checkbox"/>	317
20	3P	440	30	BS20 <input checked="" type="checkbox"/>	445
30	3P	440	20	BS30 <input checked="" type="checkbox"/>	763
63	3P+N+E	440	4	CS63 <input checked="" type="checkbox"/>	3653

Please contact Customer Care Center for Stockable and Non stockable status of references.

NORMAL STOCK ITEMS

W.E.F. January 17th, 2024

Complete range of switches & sockets suitable for both indoor & outdoor applications like Kitchens, Swimming Pools, Landscape Gardens, Exterior Walls and Other Environmentally Challenged Locations.



56SW116LE-GY



56SW216LE-GY



56SW332LE-GY

Description	IP Rating	Reference	Unit MRP [₹]
Surface Switches			
Single Pole Switches Less Enclosure			
1 Pole 250V 10A	IP66	56SW110LE-GY	3896
1 Pole 250V 16A	IP66	56SW116LE-GY	3650
1 Pole 250V 20A	IP66	56SW120LE-GY	5527
1 Pole 250V 32A	IP66	56SW132LE-GY	6528
Double Pole Switches Less Enclosure			
2 Pole 500V 16A	IP66	56SW216LE-GY	6307
2 Pole 500V 20A	IP66	56SW220LE-GY	6307
2 Pole 500V 32A	IP66	56SW232LE-GY	8369
2 Pole 500V 50A	IP66	56SW250LE-GY	9773
Triple Pole Switches Less Enclosure			
3 Pole 500V 10A	IP66	56SW310LE-GY	5833
3 Pole 500V 16A	IP66	56SW316LE-GY	6085
3 Pole 500V 20A	IP66	56SW320LE-GY	6406
3 Pole 500V 32A	IP66	56SW332LE-GY	7469
3 Pole 500V 50A	IP66	56SW350LE-GY	8617
3 Pole 500V 63A	IP66	56SW363LE-GY	10003
Four Pole Switches Less Enclosure			
4 Pole 500V 20A	IP66	56SW420LE-GY	8457



66CV563-RG



66P563-EO

Description	IP Rating	Reference	Unit MRP [₹]
IP66 Industrial Combination Switch Sockets with Enclosure			
Single Pole Switches Less Enclosure			
500V, 63A with 4 pole switch and 63A 5 Pin Socket	IP66	66CV563-RG	113367
Plug Top 5 Pin 500V 63A	IP66	66P563-EO	34027

Please contact Customer Care Center for Stockable and Non stockable status of references.

NORMAL STOCK ITEMS

W.E.F. January 17th, 2024



56SO316RP-LE-GY-EX



56SO432LE-GY



56SO532LE-GY

Description	IP Rating	Reference	Unit MRP [₹]
Surface Socket Outlets			
3 Pin Sockets Less Enclosure			
3 Pin 250V 16A Indian Standard	IP66	56SO316RP-LE-GY-EX	3674
3 Pin 250V 20A Round Pin	IP66	56SO320LE-GY	5334
3 Pin 250V 32A Round Pin	IP66	56SO332LE-GY	5885
4 Pin Sockets Less Enclosure			
4 Pin 500V 20A Round Pin	IP66	56SO420LE-GY	7891
4 Pin 500V 32A Round Pin	IP66	56SO432LE-GY	9435
4 Pin 500V 50A Round Pin	IP66	56SO450LE-GY	14517
5 Pin Sockets Less Enclosure			
5 Pin 500V 10A Round Pin	IP66	56SO510LE-GY	8527
5 Pin 500V 20A Round Pin	IP66	56SO520LE-GY	8527
5 Pin 500V 32A Round Pin	IP66	56SO532LE-GY	10126
5 Pin 500V 40A Round Pin	IP66	56SO540LE-GY	14610
5 Pin 500V 50A Round Pin	IP66	56SO550LE-GY	15000

*Alternate reference 56SO440-GY (coming soon)



56PA420-EO



56PA532-EO



56CVI520-GY

Description	IP Rating	Reference	Unit MRP [₹]
Plugs			
3 Pin Angle Plugs			
3 pin 250V 16A Round P in	IP66	56PA316RP-GY-EX	2763
3 Pin 250V 20A Round Pin	IP66	56PA320-EO	5527
3 Pin 250V 32A Round Pin	IP66	56PA332-EO	6324
4 Pin Angle Plugs			
4 Pin 500V 20A Round Pin	IP66	56PA420-EO	6735
4 Pin 500V 32A Round Pin	IP66	56PA432-EO	7011
4 Pin 500V 40A Round Pin	IP66	56PA440-EO	11661
4 Pin 500V 50A Round Pin	IP66	56PA450-EO	8319
5 Pin Angle Plugs			
5 Pin 500V 10A Round Pin	IP66	56PA510-EO	6620
5 Pin 500V 20A Round Pin	IP66	56PA520-EO	6620
5 Pin 500V 32A Round Pin	IP66	56PA532-EO	7648
5 Pin 500V 40A Round Pin	IP66	56PA540-EO	8089
5 Pin 500V 50A Round Pin	IP66	56PA550-EO	8281
Combination Switch Socket Outlet			
IP66 Interlocked Switch Socket with Enclosure			
4 Pin 500V 20A Round Pin	IP66	56CVI420-GY	28937
5 Pin 500V 20A Round Pin	IP66	56CVI520-GY	26179
5 Pin 500V 32A Round Pin	IP66	56CVI532-GY	26418

Please contact Customer Care Center for Stockable and Non stockable status of references.

NORMAL STOCK ITEMS

W.E.F. January 17th, 2024

56 Series



56DB2-GY



56CB4N-GY

Description	IP Rating	Reference	Unit MRP [₹]
Adaptable Enclosures with Gear Tray			
2 Gangpoints, 198X101X140mm	IP66	56DB2-GY	7223
Junction Boxes			
1 Gangpoint, 107X101X90mm	IP66	56JB1-GY	3143
2 Gangpoints, 204X101X90mm	IP66	56JB2-GY	5052
3 Gangpoints, 300X101X90mm	IP66	56JB3-GY	10826
4 Gangpoints, 204X198X90mm	IP66	56JB4-GY	10163

Description	Module Width	Reference	Unit MRP [₹]
Switchgear Cover Assembly			
For 1,2,3 Pole MCB with 4 Pole RCD (max. 4M Width)	4	56CB4N-GY	6,000



56FA2-GY



56E2-GY



56E1-GY-EX

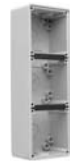

56E3-GY

Description	No. of Gangs	Reference	Unit MRP [₹]
Flush Surrounds			
Flush Surround	2	56FA2-GY	2956
Flush Surround	3	56FA3-GY	4654
Mounting Enclosures (Back Boxes)			
101X101X63mm	1	56E1-GY-EX	1374
198X101X63mm	2	56E2-GY	3298
294X101X63mm	3	56E3-GY	5235
198X198X63mm	4	56E4-GY	6735
294X198X63mm	6	56E6-GY	10769
391X198X63mm	8	56E8-GY	14129
391X391X63mm	16	56E16-GY	25600

Please contact Customer Care Center for Stockable and Non stockable status of references.

NORMAL STOCK ITEMS

W.E.F. January 17th, 2024

SWITCH TO STYLE



Perfect solutions for the perfect you



Clipsal X

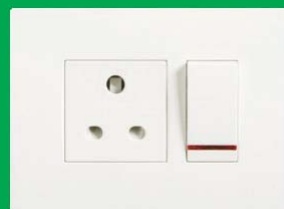

Opale



Anti-Bacterial
Range

LIVIA
Life. Style.



Avatar On



ZENcelo



Unica Pure

LIVIA - Switch to the extra-ordinary



- **Sleek Design** - 2.7mm thin plate with curved body to minimize dust accumulation
- **Stylish Looks** - Soft white texture with glossy finish
- **Robust & Strong** - Innovative honeycomb designed grid plate for extra rigidity
- **Reliable** - High grade heat-resistant polycarbonate and laser marked wiring diagrams. Tested for 4 Lac clicks
- **Easy to Install** - Snap-In / Snap-Out front loading modules and Bigger terminal holes
- **Green & Eco Friendly** - RoHS compliant range

NEW Livia *Pristine Grey*



Description	Reference for White	Unit MRP [₹]	Box Qty	Reference for Pristine Grey	Unit MRP [₹]	Box Qty
Switches						
10AX 1 way switch	P1001	139	20	P1001_PG	196	20
10AX 1 way switch with Indicator lamp	P1081	289	20	P1081_PG	403	20
10AX 2 way switch	P1002	229	20	P1002_PG	284	20
16AX 1 way switch	P1101	246	20	P1101_PG	306	20
16AX 1 way switch with Indicator lamp	P1181	346	20	P1181_PG	400	20
16AX 1 way switch (2M)	P1121	386	10	P1121_PG	511	10
16AX 2 way switch	P1102	339	10	P1102_PG	470	1
20A 1 way switch (1M) with indicator lamp	P11201	312	20	P11201_PG	407	20
20A DP switch with Indicator lamp	P1120	550	20	P1120_PG	771	20
32A DP switch with Indicator lamp	P1132	804	10	P1132_PG	1054	20
Motor Starter Switch						
25A Motor Starter switch	P1186MS	1,394	1	P1186MS_PG	1889	1
Bell Push						
10A Bell Push switch	P1005	255	20	P1005_PG	351	10
10A Bell Push switch (2M)	P1025	343	10	P1025_PG	518	10
10A bell push switch with Indicator	P1085	309	20	P1085_PG	432	20
10A bell push switch with Indicator (2M)	P1086	400	10	P1086_PG	558	10
Sockets						
6A 3Pin socket Outlet with shutter (BIS)	P2005NS	272	10	P2005NS_PG	332	10
6A/16A 3-pin Socket Outlet with Shutter	P2106	409	10	P2106_PG	487	10
Fan Regulators & Dimmers						
Step type fan regulator (1M)	P3100	788	10	P3100_PG	995	10
Step type fan regulator (2M)	P3200	916	6	P3200_PG	1155	10
Dimmer 400W (1M)	P3004	1464	6	P3004_PG	1996	6
Dimmer 1000W (2M)	P3012	2314	6	P3012_PG	2537	6
USB Charger						
USB Charger	P7002	1805	10	P7002_PG	2202	10
Livia - A+C Type USB Charger (1M)	P7003	2927	10	P7003_PG*	3523	10
Accessories						
RJ 11 Telephone outlet with shutter	P4011	225	20	P4011_PG	320	20
RJ 45 Cat 5e Data outlet with shutter	P4045	767	20	P4045_PG	947	20
RJ 45 Cat6 Data outlet with shutter	P4046	854	20	P4046_PG	1088	20
TV socket	P4500	216	20	P4500_PG	306	20
Blank off unit (1M)	P0001	61	40	P0001_PG	79	40
Foot Lamp with LED	P7001	926	1	P7001_PG	1141	1
Cord Outlet	-	-	-	P4550_PG	349	20
LED Phase Indicator	P5001	383	20	-	-	-
Hotel Series						
DND Switch	P6002	337	20	P6002_PG	384	20
MMR Switch	P6004	337	20	P6004_PG	384	20
DND & MMR Indicator	P6013	949	20	P6013_PG	1246	20
20A Key Card Switch - Electronic (3M)	P6005	4826	1	P6005_PG	6737	1
Cover Plates						
1-2 M Grid & 1 M Cover Frame	P0701	153	15	P0701_PG	209	15
1-2 M Grid & 2 M Cover Frame	P0702	153	15	P0702_PG	192	15
3 M Grid & 3 M Cover Frame	P0703	195	10	P0703_PG	226	10
4 M Grid & 4 M Cover Frame	P0704	226	8	P0704_PG	278	8
6 M Grid & 6 M Cover Frame	P0706	284	5	P0706_PG	368	5
8 M Grid & 8 M Cover Frame - Horizontal	P0708	374	5	P0708_PG	454	5
8 M Grid & 8 M Cover Frame - Square	P0709	451	5	P0709_PG	633	5
9 M Grid & 9M Cover Frame	P07010	424	5	P07010_PG	586	5
12 M Grid & 12 M Cover Frame	P0712	546	5	P0712_PG	677	5
16 M Grid & 16M Cover Frame	P07016	650	5	P07016_PG	776	5
18 M Grid & 18 M Cover Frame	P0718	786	5	P0718_PG	1103	5

Please contact Customer Care Center for Stockable and Non stockable status of references.

NORMAL STOCK ITEMS

W.E.F. January 17th, 2024

LIVIA - Switch to the extra-ordinary



P8010



P8016



P8020



P8025



P8032

Description	Reference for White	Unit MRP [₹]	Box Qty
Livia White			
10A Mini MCB	P8010	548	10
16A Mini MCB	P8016	548	10
20A Mini MCB	P8020	548	10
25A Mini MCB	P8025	548	10
32A Mini MCB	P8032	548	10



P8010_PG



P8016_PG



P8020_PG



P8025_PG



P8032_PG

Description	Reference for Pristine Grey	Unit MRP [₹]	Box Qty
Livia Pristine Grey			
10A Mini MCB, PG	P8010_PG	642	10
16A Mini MCB, PG	P8016_PG	642	10
20A Mini MCB, PG	P8020_PG	642	10
25A Mini MCB, PG	P8025_PG	642	10
32A Mini MCB, PG	P8032_PG	642	10

Please contact Customer Care Center for Stockable and Non stockable status of references.

NORMAL STOCK ITEMS

W.E.F. January 17th, 2024

Clipsal X - As Stylish As Your World

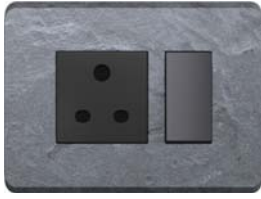

Xtra STYLE

- Trendy Dual tone colour and finish
- Contemporary sloped design that blends seamlessly with the wall
- Vibrant and youthful colours and textured finishes that can stand out or blend in
- Textured finishes to match most Indian decors – Wood, Slate & Leather

Xtra STRONG

- Made to last for more than 1 Million Clicks
- 10A rated switches to enable Grouping – add as many loads as you want
- UV Stabilized to avoid decoloring

Xtra COMFORT

- Least noise level for unobtrusive switching
- Smooth finish which avoids light reflection off the surface
- Glossy Band making it Easy to Clean
- Large plate overhang to hide wall & paint imperfections



CPX101SW1M_ WE

CPX161SWL1M_ WE



CPX20DP2M_ WE

CPX6BP2M_ WE



CPX6SK3PNS_ WE

CPXACUSB1P1M_ WE



CPX5STFAN2M_ WE

CPX21USB1P1M_ WE



CPXACUSB1P 1M_ WE

CPXTVCOAX1M_ WE



CPXCORD1M_ WE

CPXDNDIN1M_ WE



CPXMMRIN1M_ WE

CPXKEYCARDSW_ WE

Description	Reference for White	Unit MRP (₹)	Pack	Reference for Coke Grey	Unit MRP (₹)	Pack
Switches						
10AX 1 Way Switch	CPX101SW1M_WE	130	20	CPX101SW1M_GY	233	20
10A X1 Way Switch with Indicator	CPX101SWL1M_WE	320	20	CPX101SWL1M_GY	379	1
10AX 2 Way Switch	CPX102SW1M_WE	272	20	CPX102SW1M_GY	329	20
16AX 1 Way Switch	CPX161SW1M_WE	329	1	CPX161SW1M_GY	405	1
16AX 1 Way Switch with Indicator	CPX161SWL1M_WE	432	20	CPX161SWL1M_GY	511	20
16AX 2 Way Switch	CPX162SW1M_WE	436	1	CPX162SW1M_GY	515	20
10AX 1 Way Switch (2M)	CPX101SW2M_WE	385	1	-	-	-
16AX 1 Way Switch (2M)	CPX161SW2M_WE	462	1	-	-	-
16AX 1W Switch with Indicator (2M)	CPX161SWL2M_WE	531	1	-	-	-
20A DP Switch with Indicator (2M)	CPX20DP2M_WE	731	1	CPX20DP2M_GY	853	1
32A DP Switch with Indicator (2M)	CPX32DP2M_WE	1,112	1	CPX32DP2M_GY*	1683	10
Motor Starter Switch						
25A Motor Starter Switch	CPXMTSTART2M_WE	1,261	10	CPXMTSTART2M_GY	2335	10
Bell Press						
6A Bell Push	CPX6BP1M_WE	306	20	CPX6BP1M_GY	350	1
6A Bell Push (2M)	CPX6BP2M_WE	465	10	CPX6BP2M_GY	543	1
6A Bell Push with Indicator	CPX6BPL1M_WE	423	1	CPX6BPL1M_GY	506	20
6A Bell Push with Indicator (2M)	CPX6BPL2M_WE	506	1	CPX6BPL2M_GY	575	10
Sockets						
6A 3P Socket Outlet with Shutter (BIS Std.)	CPX6SK3PNS_WE	347	10	CPX6SK3PNS_GY	393	10
6A/16A 3P Socket with Shutter	CPX616SK_WE	525	10	CPX616SK_GY	593	10
Fan Regulators and Dimmers						
5-Step Fan Regulator (2M)	CPX5STFAN2M_WE	1,167	1	CPX5STFAN2M_GY	1397	5
4-Step Fan Regulator (1M), White	CPX4STFAN1M_WE	1,064	10	CPX4STFAN1M_GY	1274	10
400W Dimmer (1M)	CPXDIM1M_WE	1,149	1	CPXDIM1M_GY	1401	1
400W Dimmer (2M)	CPXDIM2M_WE	1,816	1	CPXDIM2M_GY	2272	1
1200W Dimmer	CPXDIM2M_1200_WE	2,338	1	CPXDIM2M_1200_GY	2803	5
USB Chargers						
2.1A USB Charger (1M)	CPX21USB1P1M_WE	1,891	1	CPX21USB1P1M_GY	2233	1
2.1A USB Charger (2M)	CPX21USB2P2M_WE	2,663	15	CPX21USB2P2M_GY	3827	15
2.4A A+C USB Charger(1M)	CPXACUSB1P1M_WE	3,228	10	CPXACUSB1P1M_GY	3483	10
Accessories						
RJ11 Tel Outlet, No Shutter	CPXRJ11NS1M_WE	284	5	CPXRJ11NS1M_GY	344	5
RJ11 Tel Outlet with Shutter	CPXRJ11_1M_WE	275	5	CPXRJ11_1M_GY	329	5
Twin RJ11 Tel Outlets (1M)	CPXRJ11TW1M_WE	457	12	CPXRJ11TW1M_GY	521	12
RJ45 Data Outlet with Shutter	CPXRJ451M_WE	940	12	CPXRJ451M_GY	1102	12
TV Socket	CPXTVCOAX1M_WE	258	5	CPXTVCOAX1M_GY	314	5
RJ45 Cover for Keystone Type	CPXRJ45KS1M_WE	322	5	CPXRJ45KS1M_GY	396	5
Gripped Cord Outlet	CPXCORD1M_WE	307	5	-	-	-
Foot Light with LED	CPXFTLP2M_WE	1,231	-	CPXFTLP2M_GY	1463	-
Buzzer	CPXBUZZ2M_WE	1,261	-	CPXBUZZ2M_GY	1321	2
Blank Off Unit (1M)	CPXBLANK1M_WE	72	-	CPXBLANK1M_GY	97	5
Neon Phase Indicator						
Neon Phase Indicator (Green)	CPXPHASEG1M	451	12	-	-	-
Neon Phase Indicator (Red)	CPXPHASER1M	451	12	-	-	-
Hotel Series						
DND Indicator	CPXDNDIN1M_WE	670	12	-	-	-
DND Switch	CPXDNDSW1M_WE	525	1	CPXDNDSW1M_GY	621	1
MMR Indicator	CPXMMRIN1M_WE	670	12	-	-	-
MMR Switch	CPXMMRSW1M_WE	525	1	CPXMMRSW1M_GY	621	20
16A Electronic Keycard Switch	CPXKEYCARDSW_WE	6,104	1	CPXKEYCARDSW_GY	6887	1
Shaver Socket Horizontal	CPXSHAVER_WE	6,310	1	CPXSHAVER_GY	7444	1

Please contact Customer Care Center for Stockable and Non stockable status of references.

✓ NORMAL STOCK ITEMS

W.E.F. January 17th, 2024

Clipsal X - As Stylish As Your World



White



Coke Grey



Metallic Copper



Charcoal Black

Description	Reference for White	Unit MRP [₹]	Pack	Reference for Coke Grey	Unit MRP [₹]	Pack	Reference for Metallic Copper	Unit MRP [₹]	Pack	Reference for Charcoal Black	Unit MRP [₹]	Pack
Cover Plates												
1M or 2M Grid & 1M Cover Frame	CPXCP1M_WE	178	1	CPXCP1M_GY	305	10	CPXCP1M_MC	354	10	CPXCP1M_CB	354	10
1M or 2M Grid & 2M Cover Frame	CPXCP2M_WE	193	10	CPXCP2M_GY	329	10	CPXCP2M_MC	384	10	CPXCP2M_CB	384	10
3M Grid & 3M Cover Frame	CPXCP3M_WE	221	10	CPXCP3M_GY	374	10	CPXCP3M_MC	439	10	CPXCP3M_CB	439	10
3M Uni Grid & 3M Cover Frame	CPXCP3MU_WE	263	10	-	-	-	-	-	-	-	-	-
4M Grid & 4M Cover Frame	CPXCP4M_WE	261	1	CPXCP4M_GY	442	10	CPXCP4M_MC	516	10	CPXCP4M_CB	516	10
6M Grid & 6M Cover Frame	CPXCP6M_WE	378	5	CPXCP6M_GY	642	5	CPXCP6M_MC	751	1	CPXCP6M_CB	751	1
8M Grid & 8M Cover Frame, Horizontal	CPXCP8ML_WE	468	1	CPXCP8ML_GY	795	5	CPXCP8ML_MC	930	5	CPXCP8ML_CB	930	5
8M Grid & 8M Cover Frame, Square	CPXCP8MSQ_WE	506	1	CPXCP8MSQ_GY	984	1	CPXCP8MSQ_MC	1173	1	CPXCP8MSQ_CB	1173	1
9M Cover Frame	CPXCP9M_WE	499	5	CPXCP9M_GY	842	5	-	-	-	-	-	-
9M Grid & 9M Cover Frame	-	-	-	-	-	-	-	-	-	CPXCP9M_CB	1272	5
12M Grid & 12M Cover Frame	CPXCP12M_WE	572	1	CPXCP12M_GY	1154	1	CPXCP12M_MC	1292	5	CPXCP12M_CB	1292	5
16M Cover Frame	CPXCP16M_WE	688	5	CPXCP16M_GY	1123	5	-	-	-	-	-	-
18M Grid & 18M Cover Frame	CPXCP18M_WE	884	5	-	-	-	-	-	-	-	-	-

Please contact Customer Care Center for Stockable and Non stockable status of references.

NORMAL STOCK ITEMS

W.E.F. January 17th, 2024

Clipsal X - As Stylish As Your World



Sheesham



Slate

Description	Reference for Sheesham	Unit MRP [₹]	Pack	Reference for Slate	Unit MRP [₹]	Pack
Cover Plates						
1M or 2M Grid & 1M Cover Frame	CPXCP1M_SH	560	10	CPXCP1M_SL	598	10
1M or 2M Grid & 2M Cover Frame	CPXCP2M_SH	607	1	CPXCP2M_SL	607	1
3M Grid & 3M Cover Frame	CPXCP3M_SH	693	10	CPXCP3M_SL	693	10
4M Grid & 4M Cover Frame	CPXCP4M_SH	816	1	CPXCP4M_SL	816	1
6M Grid & 6M Cover Frame	CPXCP6M_SH	1185	1	CPXCP6M_SL	1265	1
8M Grid & 8M Cover Frame, Horizontal	CPXCP8ML_SH	1470	5	CPXCP8ML_SL	1470	5
8M Grid & 8M Cover Frame, Square	CPXCP8MSQ_SH	1736	1	CPXCP8MSQ_SL	1854	1
12M Grid & 12M Cover Frame	CPXCP12M_SH	2038	5	CPXCP12M_SL	2177	5

Please contact Customer Care Center for Stockable and Non stockable status of references.

NORMAL STOCK ITEMS

W.E.F. January 17th, 2024

Wiring Diagram Clipsal X

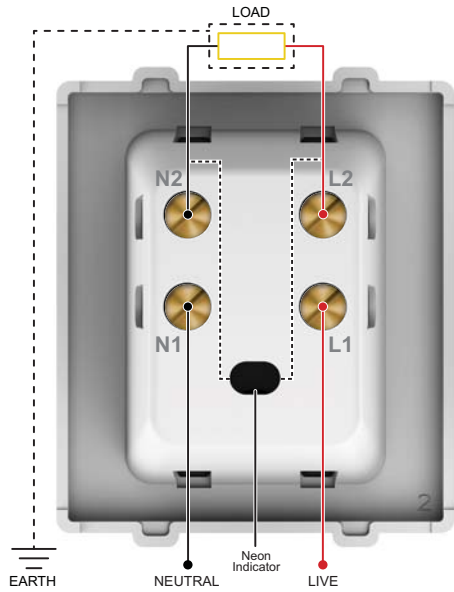

> 20A DP Switch with Indicator (2M)
CPX20DP2M_WE, CPX20DP2M_GY

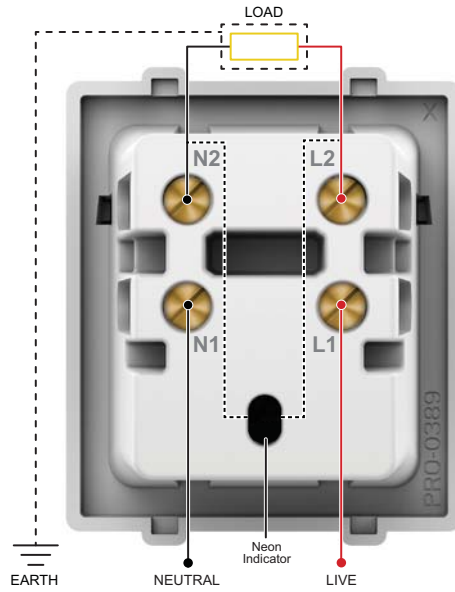

> 32A DP Switch with Indicator (2M)
CPX32DP2M_WE, CPX32DP2M_GY

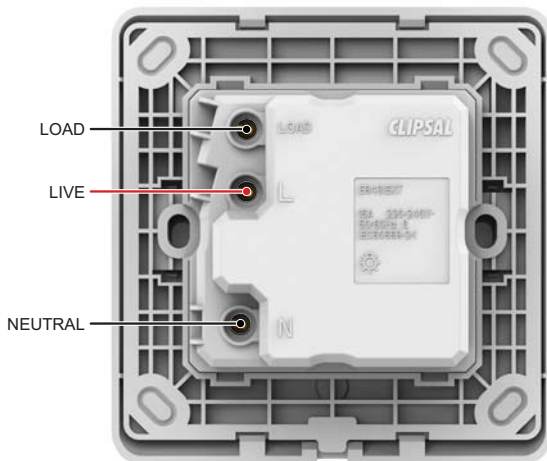

> 16A Electronic Keycard Switch
CPXKEYCARDSW_WE, CPXKEYCARDSW_GY

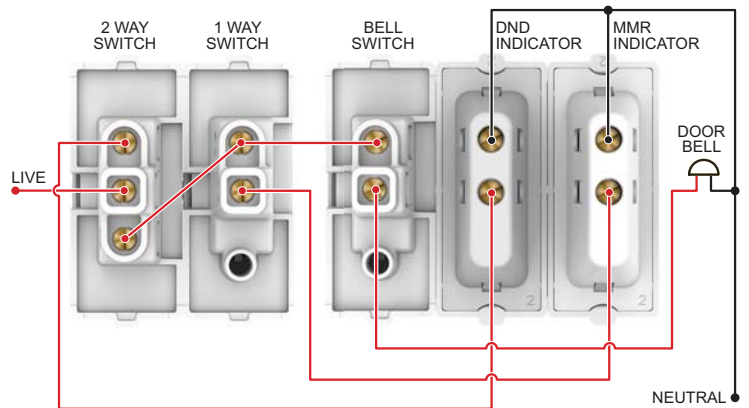

> DND Switch > MMR Switch
> DND Indicator > MMR indicator
CPXDND1M_WE, CPXDND1M_GY,
CPXMMRSW1M_WE, CPXMMRSW1M_GY,
CPXDNDIN1M_WE, CPXMMRIN1M_WE

Please contact Customer Care Center for Stockable and Non stockable status of references.

☑ NORMAL STOCK ITEMS

W.E.F. January 17th, 2024

Opale - Switches with Satin Finish

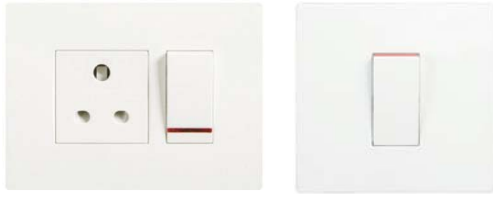

- **Patented Smooth Satin Finish** - Scratch Resistant, Easy to Clean & Prevents light reflection off surface
- **Safe to Use** - High grade flame retardant polycarbonate material & Child Proof sockets with unique shutter design
- **Hassle Free Operation** - 'Soft sound' switches with Gold plated Data Socket contacts for better connection
- **Easy to Install** - Snap-In / Snap-Out front loading modules and terminals with indented screws
- **Green & Eco Friendly** - RoHS compliant range



X1001WH



X1286WH



X1186WH



X1005WH



X1085WH



X2005WHNS



X2106WH



X4020WH



X3200WH



X3104WH



X4010WH



X7003WH



X5001



X5002

Description	Reference for White	Unit MRP [₹]	Pack	Reference for Coke Grey	Unit MRP [₹]	Pack
Switches						
6AX 1 way switch	X1001WH	234	20	AAKY1001	297	20
6AX 1 way switch with Indicator lamp	X1081WH	431	20	AAKY1081	510	20
6AX 2 way switch	X1002WH	322	20	AAKY1002	434	20
16AX 1 way switch	X1101WH	376	20	AAKY1101	471	20
16AX 1 way switch with Indicator lamp	X1181WH	527	20	AAKY1181	622	20
16AX 2 way switch	X1102WH	507	20	AAKY1102	694	20
16AX 1 way switch (2M)	X1121WH	572	10	-	-	-
6AX 1 way switch with Indicator (2M)	X1028WH	583	10	-	-	-
16AX 1 way switch with Indicator (2M)	X1128WH	715	10	-	-	-
20A DP switch with Indicator (2M)	X1286WH	871	10	AAKY1286	1199	10
32A DP switch (2M)	AAKX1232	1297	10	-	-	-
Motor Starter Switch						
25A Motor Starter switch	X1186WH	2,421	10	-	-	-
Bell Push						
6A Bell Push	X1005WH	364	20	AAKY1005	516	20
6A Bell Push (2M)	X1025WH	521	10	AAKY1025	733	10
6A Bell Push with Indicator	X1085WH	560	20	-	-	-
6A Bell Push with Indicator (2M)	X1086WH	637	10	-	-	-
Sockets						
6A 3-Pin Socket outlet with Shutter (BIS)	X2005WHNS	396	10	AAKY2005NS	478	10
6A/16A 3-Pin Socket Outlet with Shutter	X2106WH	606	10	AAKY2106	721	10
Fan Regulators & Dimmers						
Step Fan Regulator (1M)	X3100WH	1015	10	AAKY3100	1327	10
Step type fan regulator (2M)	X3200WH	1422	5	AAKY3200	1701	5
Dimmer 400W (1M)	X3104WH	1273	10	AAKY3104	1769	10
Dimmer 400W (2M)	X3004WH	1981	5	-	-	-
USB Chargers						
2 Gang USB Charger - 2.1A (2M)	X7003WH	3,744	15	AAKY7003	4765	15
Accessories						
RJ11 Telephone outlet (no shutter)	X4010WH	328	10	-	-	-
RJ11 Telephone outlet with shutter	X4011WH	325	10	AAKY4011	463	10
Twin RJ11 Telephone outlets (no shutter) (1M)	X4020WH	530	10	-	-	-
RJ45 Data Outlet with shutter	X4045WH	1121	20	AAKY4045	1433	20
TV Socket	X4500WH	305	10	AAKY4500	441	10
RJ45 Cover for Key Stone Type	X4050WH	435	10	-	-	-
Gripped Cord Outlet	X4550WH	393	10	-	-	-
Buzzer	X3300WH	1488	2	AAKY3300	1779	2
Blank off unit (1M)	X0001WH	87	10	AAKY0001	123	20
Neon Phase Indicator (Red)	X5001	527	20	-	-	-
Neon Phase Indicator (Green)	X5002	609	20	-	-	-
Neon Phase Indicator (Yellow)	X5003	609	20	-	-	-

Please contact Customer Care Center for Stockable and Non stockable status of references.

NORMAL STOCK ITEMS

W.E.F. January 17th, 2024

Opale - Switches with Satin Finish



AAKX6002 + AAKX6004 + X0702



AAKX6006 + X0703



AAKX6005

Description	Reference	Unit MRP [₹]	Pack
Hotel Series*			
DND Panel	AAKX6001	947	20
DND Switch	AAKX6002	738	20
MMR Panel	AAKX6003	894	20
MMR Switch	AAKX6004	738	20
Key Tag Switch (Mechanical Type 20 A)	AAKX6005	1779	1
Shaver Socket	AAKX6006	7851	1

*Available in white colour only



X0733WH



X0703



AAKY0804

Description	Reference for White	Unit MRP [₹]	Pack	Reference for Coke Grey	Unit MRP [₹]	Pack
Cover Plates						
1-2 M Grid & 1 M Cover Frame	X0701	213	10	AAKY0801	281	10
1-2 M Grid & 2 M Cover Frame	X0702	226	10	AAKY0802	296	10
3 M Grid & 3 M Cover Frame	X0703	267	10	AAKY0803	325	10
3 M Universal Grid & 3 M Cover Frame	X0733WH	383	10	-	#N/A	-
4 M Grid & 4 M Cover Frame	X0704	313	10	AAKY0804	418	10
6 M Grid & 6 M Cover Frame	X0706	436	5	AAKY0806	517	5
8 M Grid & 8 M Cover Frame - Horizontal	X0708	568	5	AAKY0808	674	5
8 M Grid & 8 M Cover Frame - Square	X0709	671	5	AAKY0809	1014	5
12 M Grid & 12 M Cover Frame	X0712	789	5	AAKY0812	1189	5
18 M Grid & 18 M Cover Frame	AAKX0718	1028	5	-	-	-

Please contact Customer Care Center for Stockable and Non stockable status of references.

NORMAL STOCK ITEMS

W.E.F. January 17th, 2024

Unica Pure - Irresistibly Beautiful



Wood



Glass



Metal Rhodium Black



Sandy Beige

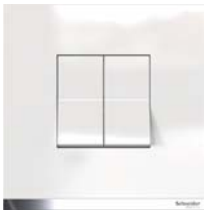

Polar White



Volcanic Grey



Pearl Black



Pewter Grey



Oak

Irresistibly Beautiful

- Authentic finishes - developed from the high quality natural material
- Ingenious Design - Demarcated dolly depicting clear on/off mode of the switch
- Modish Colors - perfectly gel with neutral, accent wall colors and blends perfectly with any decor

Irresistibly Safe & Sturdy

- Self Piercing Terminal - ensuring completely safe, robust and fast installation
- Facile & Guarded Technology - reduces tension in the switch rocker & increases the longevity of the switch
- Plated metal with Plastic over molded Gridplate - Robust, rigid & shock proof gridplate, ensuring durable installation on the metal box

Irresistibly Easy

- Key Hole Feature - Angular and linear adjustments of the gridplate can be easily achieved
- Revolutionary Ease of Mounting with Indicators & Markings

Irresistibly Sustainable

- Green Premium - Complies to HIGHEST INTERNATIONAL STANDARD of Green
- Certification for manufactured products (RoHS, REACH, PEP, EoLI) and is 100% Recyclable

Irresistibly Innovative

- Future Ready - Features of Voice & Mobile control to fit with smart homes

Irresistibly Versatile

- One Stop Shop - Extensive range covering residential, office, commercial or hospitality
- **Intermediate switches to control multiple 2way switches**

Unica Pure switches with six patented technologies



Life Guarded Sockets

Eliminate possibility of Single Pin Insertion making it extra safe for children

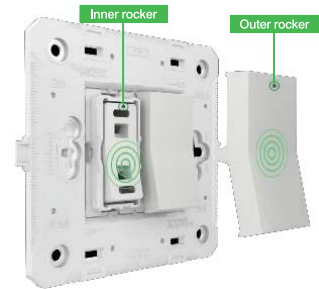

Facile & Guarded Technology

Reduces tension in the switch rocker & increases the longevity of the switch

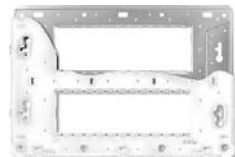

Key Hole Feature

Angular and linear adjustments of the gridplate can be easily achieved



Adjoining (V) Feature Technology

Ensuring perfect alignment of switches



Self-piercing Terminal

Ensuring completely safe, robust and fast installation

Please contact Customer Care Center for Stockable and Non stockable status of references.

NORMAL STOCK ITEMS

W.E.F. January 17th, 2024

Unica Pure - Irresistibly Beautiful



UNS61SW1M_WE



UNS161SWL1M_WE



UNS162MSWL1M_WE



UNS10SW1M_WE



UNS6SK3P2MNS_WE



UNS616SK2M_WE



UNS162SW2M_WE



UNSMTSTART2M_WE



UNS21USB2P2M_WE



UNS21USB1P1M_WE



UNS5STFAN2M_WE



UNSACUSB1P1M_WE



UNSHDMI_WE



UNSCPTVDIG1M_WE



UNSSKTLT2M_WE

Description	Reference for Polar White	Unit MRP [₹]	Pack	Reference for Volcanic Grey	Unit MRP [₹]	Pack
6A Switches						
6AX 1 Way Switch	UNS61SW1M_WE	220	20	UNS61SW1M_GY	253	20
6AX 1 Way Switch With Indicator	UNS61SWL1M_WE	392	20	UNS61SWL1M_GY	449	20
6AX 2 Way Switch	UNS62SW1M_WE	314	10	UNS62SW1M_GY	351	10
6A Intermediate Switches						
10AX Intermediate Switch	UNS10SW1M_WE	1,404	1	UNS10SW1M_GY	1,693	1
16AX Switches						
16AX 1 Way Switch	UNS161SW1M_WE	367	20	UNS161SW1M_GY	428	20
16AX 1 Way Switch With Indicator	UNS161SWL1M_WE	439	20	UNS161SWL1M_GY	511	20
16AX 2 Way Switch, Polar White	UNS162SW1M_WE	486	10	UNS162SW1M_GY	572	10
16A Master Switch, 2 Way, With Locator & Label	UNS162MSWL1M_WE	1,122	20	UNS162MSWL1M_GY	1,326	1
16Ax 2 Way 2M Switch	UNS162SW2M_WE	486	10	UNS162SW2M_GY	578	10
16AX~20A 1Way switch with Neon indicator	UNS201SWL1M_WE	426	10	UNS201SWL1M_GY	504	10
Double Pole Switches						
20A Double Pole Switch With Indicator	UNS20DP2M_WE	868	10	UNS20DP2M_GY	1022	1
32A Double Pole Switch With Indicator	UNS32DP2M_WE	1328	10	UNS32DP2M_GY	1583	10
Motor Starter Switch						
Motor Starter	UNSMTSTART2M_WE	1,978	10	UNSMTSTART2M_GY	2,340	10
Bell Switches						
6A Bellpress, 1M	UNS6BP1M_WE	325	20	UNS6BP1M_GY	381	20
6A Bellpress With Indicator, 1M	UNS6BPL1M_WE	450	20	UNS6BPL1M_GY	536	1
6A Bellpress, 2M, Polar White	UNS6BP2M_WE	447	10	UNS6BP2M_GY	525	1
6A Bellpress With Indicator, 2M	UNS6BPL2M_WE	551	10	UNS6BPL2M_GY	647	1
6A Sockets						
6A 3PIN Sockets outlet with Shutter (BIS)	UNS6SK3P2MNS_WE	464	10	UNS6SK3P2MNS_GY	511	10
6/16A Sockets						
6/16A Socket	UNS616SK2M_WE	543	10	UNS616SK2M_GY	675	10
USB Chargers						
2.1A 5V USB Charger, 2 Module	UNS21USB2P2M_WE	3,295	10	UNS21USB2P2M_GY	3894	1
2.1A 5V USB Charger, 1 Module	UNS21USB1P1M_WE	2,276	20	UNS21USB1P1M_GY	2699	20
2.4A 5V A+C USB Charger, 1 Module	UNSACUSB1P1M_WE	3,512	10	UNSACUSB1P1M_GY	3949	10
Blank Plates						
Single Module Blank Plate	UNSBANK1M_WE	79	20	UNSBANK1M_GY	88	20
Fan Regulators						
4 Steps 360 Deg Fan Regulator, 1M	UNS4STFAN1M_WE	952	20	UNS4STFAN1M_GY	1103	20
5 Steps 360 Deg Fan Regulator, 2M	UNS5STFAN2M_WE	1509	10	UNS5STFAN2M_GY	1703	10
Emergency Light Indicator						
Emergency Light Module*	UNSEMERGENCY2M_WE	10883	1	-	-	-
Network, Connectivity & Media Series						
RJ 11 (WITH Shutter)	UNSRJ11_1M_WE	302	20	UNSRJ11_1M_GY	355	20
RJ 45 (WITH Shutter), Cat 6	UNSRJ45_1M_WE	1103	20	UNSRJ45_1M_GY	1277	20
TV Socket Coaxial	UNSTVCOAX1M_WE	312	20	UNSTVCOAX1M_GY	372	20
Volume Control	UNSVOLCTRL2M_WE	2460	10	UNSVOLCTRL2M_GY	2933	10
HDMI	UNSHDMI_WE	2097	20	UNSHDMI_GY	2365	20
TV Socket Digital (F-Connector)	UNSCPTVDIG1M_WE	354	1	-	-	-
Shaver Socket	UNSSHAYER_WE	8079	1	UNSSHAYER_GY	8811	1
PIR Motion Sensor*	UNSPIR_WE	10302	4	-	-	-

Please contact Customer Care Center for Stockable and Non stockable status of references.

NORMAL STOCK ITEMS

W.E.F. January 17th, 2024

Unica Pure - Irresistibly Beautiful



UNSEKCSW_WE



UNSCURTAINSW2M_WE



UNSSHAVER_WE



UNSPIR_WE



UNSPHASEG1M



UNSPHASER1M

Description	Reference for Polar White	Unit MRP [₹]	Pack	Reference for Volcanic Grey	Unit MRP [₹]	Pack
Hotel Series*						
Skirt Light with LED, 2M	UNSSKTLT2M_WE	1,377	10	UNSSKTLT2M_GY	1,612	10
Buzzer	UNSBUZZER1M_WE	2,160	10	UNSBUZZER1M_GY	2,368	10
Cord Outlet	UNSCORD1M_WE	400	20	UNSCORD1M_GY	445	20
DND / MMR Indicator*	UNSDM1M	1,458	20	-	-	-
DND/MMR Indicator v.2	UNSDM1M_WE	1,719		UNSDM1M_GY	1,964	
DND Switch	UNSDNDSW1M_WE	581	10	UNSDNDSW1M_GY	709	10
MMR Switch	UNSMMSW1M_WE	581	10	UNSMMSW1M_GY	709	10
Electronic Keycard Switch, White	UNSEKCSW_WE	7,792	5	UNSEKCSW_GY	9,007	5
Electronic Keycard Switch, Sandy Beige	UNSEKCSW_CL	7,946	5	UNSEKCSW_CD	7,839	5
Curtain Control Switch	UNSCURTAINSW2M_WE	1,021	10	UNSCURTAINSW2M_GY	1,184	10

Description	Reference	Unit MRP [₹]	Pack
LED Phase Indicator			
LED Phase Indicator, Red	UNSPHASER1M	508	20
LED Phase Indicator, Green	UNSPHASEG1M	508	20
LED Phase Indicator, Yellow	UNSPHASEY1M	508	20

Please contact Customer Care Center for Stockable and Non stockable status of references.

NORMAL STOCK ITEMS

W.E.F. January 17th, 2024

Unica Pure - Irresistibly Beautiful

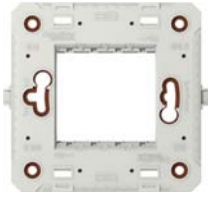

UNPGP2M



UNPGP6M

Description	Reference for Gridplate	Unit MRP [₹]	Pack
Cover Plates			
2Module Gridplate (Fixing Frame) Only	UNPGP2M	175	4
3Module Gridplate (Fixing Frame) Only	UNPGP3M	214	9
4Module Gridplate (Fixing Frame) Only	UNPGP4M	246	8
6Module Gridplate (Fixing Frame) Only	UNPGP6M	334	9
8M Gridplate (Fixing Frame) Only, Linear	UNPGP8ML	345	9
8M Gridplate (Fixing Frame) Only, Square	UNPGP8MSQ	442	6
12Module Gridplate (Fixing Frame) Only	UNPGP12M	515	6



UNPSP2M_WD



UNPSP6M_WD

Description	Reference for Oak Wood	Unit MRP [₹]	Pack
Cover Plates			
1 Module Wood Cover Frame Only	UNPSP1M_WD	2,478	6
2 Module Wood Cover Frame Only	UNPSP2M_WD	2,634	6
3 Module Wood Cover Frame Only	UNPSP3M_WD	3,260	6
4 Module Wood Cover Frame Only	UNPSP4M_WD	3,772	6
6 Module Wood Cover Frame Only	UNPSP6M_WD	5,383	3
8 Module Wood Cover Frame Only, Linear	UNPSP8ML_WD	6,541	3
8 Module Wood Cover Frame Only, Square	UNPSP8MSQ_WD	7,803	6
12 Module Wood Cover Frame Only	UNPSP12M_WD	10,433	6



UNPSP2M_GW



UNPSP6M_GW

Description	Reference for Aqua Glass	Unit MRP [₹]	Pack
Cover Plates			
1Module Aqua Glass Cover Frame Only	UNPSP1M_GW	1,377	6
2Module Aqua Glass Cover Frame Only	UNPSP2M_GW	1,549	6
3Module Aqua Glass Cover Frame Only	UNPSP3M_GW	1,744	6
4Module Aqua Glass Cover Frame Only	UNPSP4M_GW	1,822	6
6Module Aqua Glass Cover Frame Only	UNPSP6M_GW	3,292	3
8M Aqua Glass Cover Frame Only, Linear	UNPSP8ML_GW	3,741	3
8M Aqua Glass Cover Frame Only, Square	UNPSP8MSQ_GW	4,738	6
12Module Aqua Glass Cover Frame Only	UNPSP12M_GW	5,876	6

Please contact Customer Care Center for Stockable and Non stockable status of references.

NORMAL STOCK ITEMS

W.E.F. January 17th, 2024

Unica Pure - Irresistibly Beautiful



UNPSP2M_GB



UNPSP6M_GB

Description	Reference for Pearl Black Glass	Unit MRP [₹]	Pack
Cover Plates			
1M Pearl Black Glass Cover Frame Only	UNPSP1M_GB	1,630	6
2M Pearl Black Glass Cover Frame Only	UNPSP2M_GB	1,833	6
3M Pearl Black Glass Cover Frame Only	UNPSP3M_GB	1,993	6
4M Pearl Black Glass Cover Frame Only	UNPSP4M_GB	2,160	6
6M Pearl Black Glass Cover Frame Only	UNPSP6M_GB	3,883	3
8M Pearl Black Glass CF Only, Linear	UNPSP8ML_GB	4,407	3
8M Pearl Black Glass CF Only, Suare	UNPSP8MSQ_GB	5,584	6
12M Pearl Black Glass Cover Frame Only	UNPSP12M_GB	6,915	6



UNPSP2M_ML



UNPSP6M_ML

Description	Reference for Pewter Grey Metal	Unit MRP [₹]	Pack
Cover Plates			
1 Module Pw Grey Metal Cover Frame Only	UNPSP1M_ML	2,448	6
2 Module Pw Grey Metal Cover Frame Only	UNPSP2M_ML	2,717	6
3 Module Pw Grey Metal Cover Frame Only	UNPSP3M_ML	3,092	6
4 Module Pw Grey Metal Cover Frame Only	UNPSP4M_ML	3,251	6
6 Module Pw Grey Metal Cover Frame Only	UNPSP6M_ML	5,757	3
8Module Pw Grey Metal CF Only, Linear	UNPSP8ML_ML	6,486	3
8 Module Pw Grey Metal CF Only, Suare	UNPSP8MSQ_ML	8,238	6
12Module Pw Grey Metal Cover Frame Only	UNPSP12M_ML	10,219	6

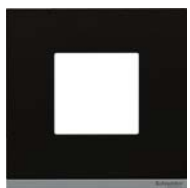

UNPSP2M_MD

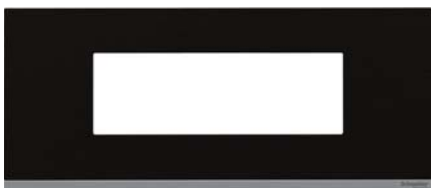

UNPSP6M_MD

Description	Reference for Black Metal	Unit MRP [₹]	Pack
Cover Plates			
1Module Rh Black Metal Cover Frame Only	UNPSP1M_MD	2,448	6
2Module Rh Black Metal Cover Frame Only	UNPSP2M_MD	2,717	6
3Module Rh Black Metal Cover Frame Only	UNPSP3M_MD	3,092	6
4Module Rh Black Metal Cover Frame Only	UNPSP4M_MD	3,251	6
6Module Rh Black Metal Cover Frame Only	UNPSP6M_MD	5,757	3
8Module Rh Black Metal CF Only, Linear	UNPSP8ML_MD	6,486	3
8 Module Rh Black Metal CF Only, Suare	UNPSP8MSQ_MD	8,238	6
12M Rh Black Metal Cover Frame Only	UNPSP12M_MD	10,219	6

Please contact Customer Care Center for Stockable and Non stockable status of references.

NORMAL STOCK ITEMS

W.E.F. January 17th, 2024

Unica Pure - Irresistibly Beautiful



Description	Reference for Painted Sandy Biege	Unit MRP [₹]	Pack	Reference for Painted Mocha Brown	Unit MRP [₹]	Pack	Reference for Molded Polar White	Unit MRP [₹]	Pack	Reference for Molded Volcanic Grey	Unit MRP [₹]	Pack
Cover Plates												
1 Module Plastic Surround and Gridplate	UNSCP1M_CL	477	20	UNSCP1M_CD	468	20	UNSCP1M_WE	245	20	UNSCP1M_GY	348	20
2 Module Plastic Surround and Gridplate	UNSCP2M_CL	541	20	UNSCP2M_CD	522	20	UNSCP2M_WE	273	20	UNSCP2M_GY	389	20
3 Module Plastic Surround and Gridplate	UNSCP3M_CL	607	10	UNSCP3M_CD	609	10	UNSCP3M_WE	312	10	UNSCP3M_GY	444	10
4 Module Plastic Surround and Gridplate	UNSCP4M_CL	636	14	UNSCP4M_CD	636	14	UNSCP4M_WE	329	14	UNSCP4M_GY	474	14
6 Module Plastic Surround and Gridplate	UNSCP6M_CL	1,133	5	UNSCP6M_CD	1095	5	UNSCP6M_WE	574	5	UNSCP6M_GY	818	5
8 Module Plastic Surround and Gridplate, Linear	UNSCP8ML_CL	1,258	5	UNSCP8ML_CD	1235	5	UNSCP8ML_WE	646	5	UNSCP8ML_GY	914	5
8 Module Plastic Surround and Gridplate, Square	UNSCP8MSQ_CL	1,563	10	UNSCP8MSQ_CD	1563	10	UNSCP8MSQ_WE	835	10	UNSCP8MSQ_GY	1266	10
9 Module Plastic Surround and Gridplate	-	-	-	-	-	-	UNSCP9M_WE	1043	5	UNSCP9M_GY	1629	5
12 Module Plastic Surround and Gridplate	UNSCP12M_CL	1,954	5	UNSCP12M_CD	1,957	5	UNSCP12M_WE	1156	5	UNSCP12M_GY	2033	5
16 Module Plastic Surround and Gridplate	UNSCP16M_CL	2,649	5	UNSCP16M_CD	2,649	5	UNSCP16M_WE	1423	5	UNSCP16M_GY	2455	5
18 Module Plastic Surround and Gridplate	UNSCP18M_CL	2,838	1	UNSCP18M_CD	2,838	1	UNSCP18M_WE	1475	1	UNSCP18M_GY	2621	1

Please contact Customer Care Center for Stockable and Non stockable status of references.

NORMAL STOCK ITEMS

W.E.F. January 17th, 2024

Wiring Diagram Unica Pure

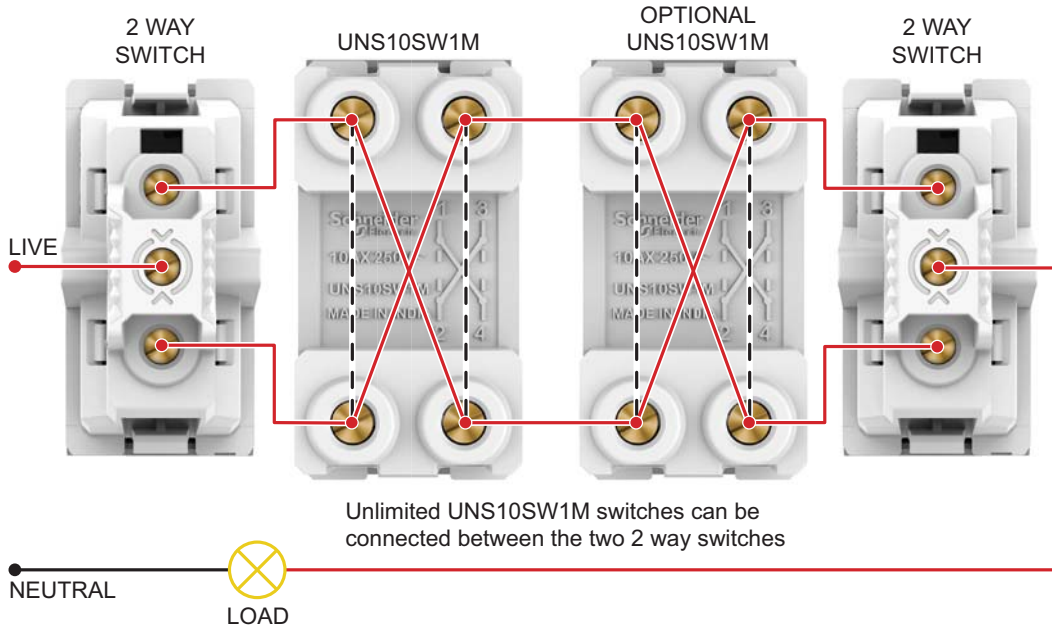

> 10AX Intermediate Switch

UNS10SW1M_WE, UNS10SW1M_GY

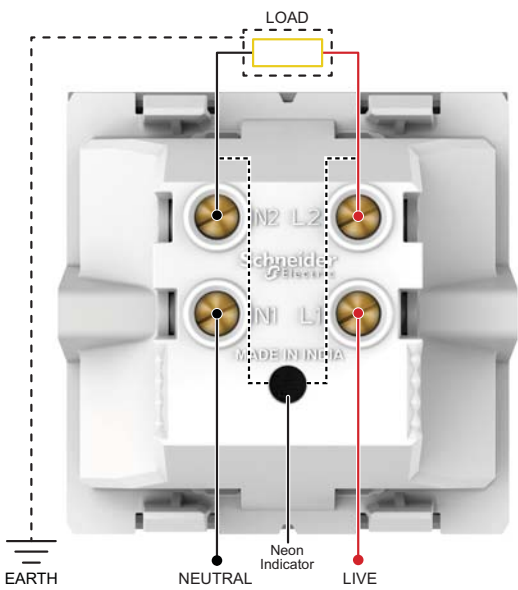

> 20A Double Pole Switch With Indicator

UNS20DP2M_WE, UNS20DP2M_GY

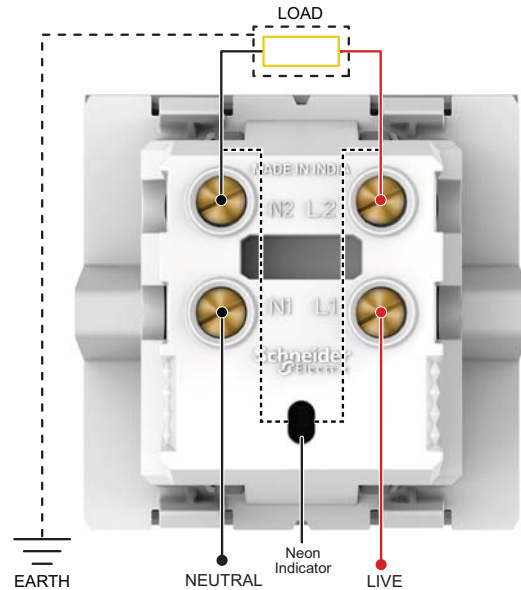

> 32A Double Pole Switch With Indicator

UNS32DP2M_WE, UNS32DP2M_GY

Please contact Customer Care Center for Stockable and Non stockable status of references.

☑ NORMAL STOCK ITEMS

W.E.F. January 17th, 2024

Wiring Diagram Unica Pure

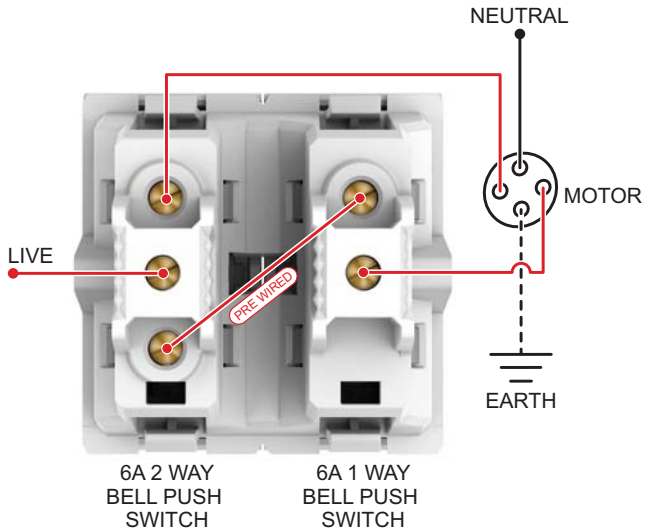

> **Curtain Control Switch**
UNSCURTAINSW2M_WE

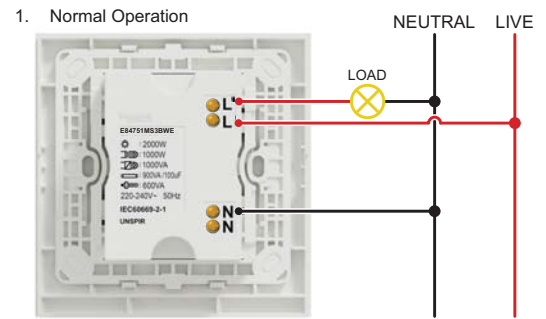

> **PIR Motion Sensor***
UNSPIR_WE

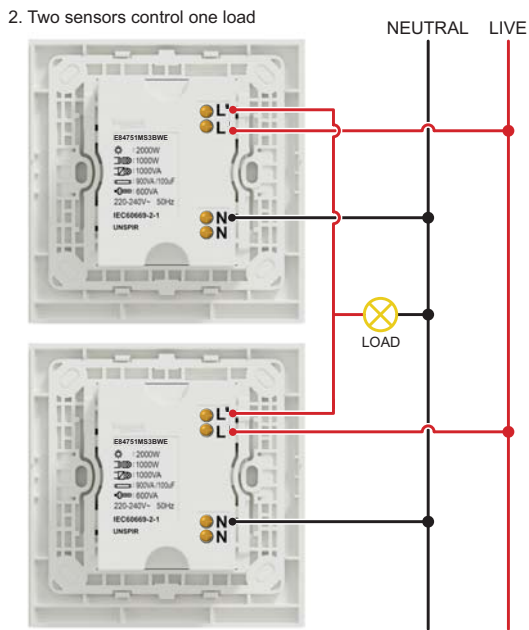

> **PIR Motion Sensor***
UNSPIR_WE

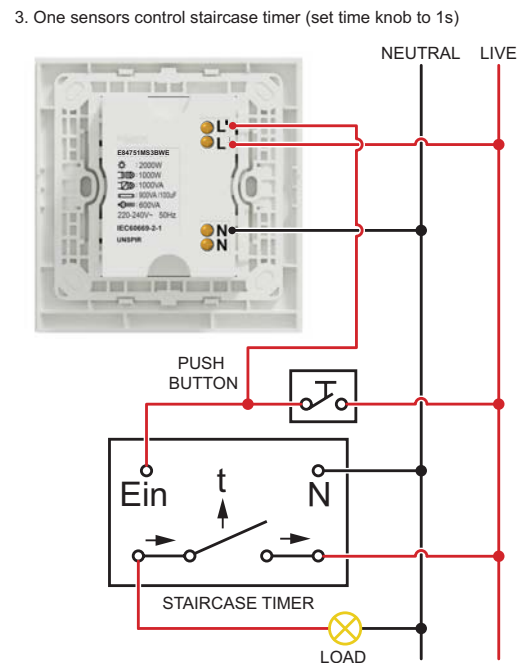

> **PIR Motion Sensor***
UNSPIR_WE

Please contact Customer Care Center for Stockable and Non stockable status of references.

NORMAL STOCK ITEMS

W.E.F. January 17th, 2024

Wiring Diagram Unica Pure

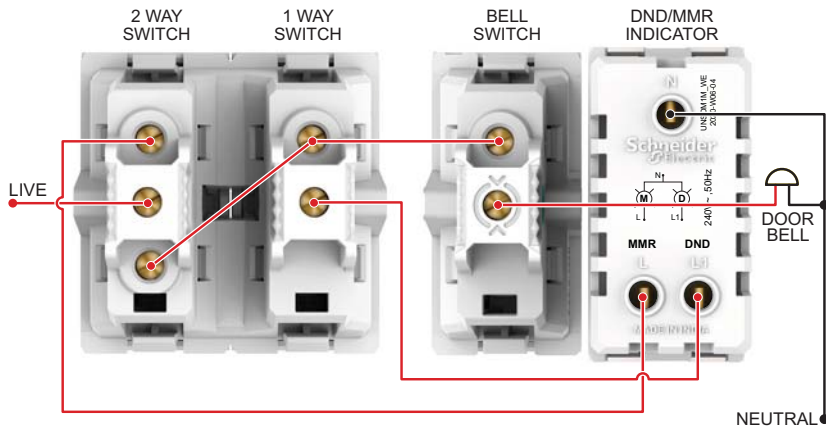

> DND/MMR Indicator v.2 > Do Not Disturb Switch
 > Make My Room Switch > DND Switch
 > MMR Switch

UNSDM1M_WE, UNSDM1M_GY, UNSDNDSW1M_WE,
 UNSDNDSW1M_GY, UNSMMRSW1M_WE, UNSMMRSW1M_GY

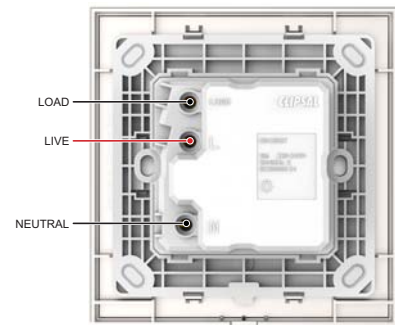

> Unica Pure Key Card

UNSEKCSW_WE, UNSEKCSW_GY,
 UNSEKCSW_CL, UNSEKCSW_CD

ZENcelo India - The Revolutionary Full-Flat Switch



- **World's First and only Full-Flat Mechanical Switch**
- **Patented Iso-Motion Technology** - Ensures switch stays in the same position whether On or Off
- **Robust & Strong** - Made of corrosion-resistant, heat-resistant and impact-resistant polycarbonate
- **Safe to Use** - Electric arc encapsulated switches and Data Sockets with patented integrated shutter
- **Designed to Last** - Switches tested to 80,000 times; Sockets tested to 15,000 cycles.
- **Green & Eco Friendly** - RoHS compliant range
- **Dust Proof Cover**
- **All Dark Grey references covered with electrostatic protective film**
- **Intermediate switches to control multiple 2way switches**
- **16AX~20A 1 Way 2G Switch (1M) - IN8444/16: Single: switch to control two loads**



Description	Reference for White	Unit MRP [₹]	Pack	Reference for Dark Grey	Unit MRP [₹]	Pack
Switches						
6AX 1 Way switch	IN8401	408	10	IN8401(BZ)	511	10
6AX 1 Way switch (2M)	IN8421	718	10	IN8421(BZ)	866	10
6AX 2 Way switch	IN8402	511	10	IN8402(BZ)	613	10
6AX 1 Way switch with Neon	IN8481	642	10	IN8481(BZ)	769	10
16AX~20A 1 Way switch	IN8401/16	616	10	IN8401/16(BZ)	750	10
16AX~20A 1 Way switch (2M)	IN8421/16	958	10	-	-	-
16AX~20A 1 Way switch with Neon	IN8481/16	876	10	IN8481/16(BZ)	1038	10
16AX~20A 1 Way switch with Neon (2M)	IN8482/16	1132	10	IN8482/16(BZ)	1333	10
16AX~20A 2 Way switch	IN8402/16	867	10	IN8402/16(BZ)	1124	10
16AX~20A 2 Way switch (2M)	IN8422/16	1038	10	IN8422/16(BZ)	1339	10
16AX~20A 1 Way 2G switch (1M)	IN8444/16	1008	10	IN8444/16(BZ)	1215	10
10AX Intermediate switch	IN8430/IM	1596	10	IN8430/IM(BZ)	1804	1
20A DP Switch with Neon (2M)	IN8486/20	1337	5	IN8486/20(BZ)	1750	5
32A DP Switch with Neon (2M)	IN8486/32	2100	5	IN8486/32(BZ)	2523	5
Motor Starter Switch						
25A Motor Starter switch (2M)	IN8425MS	3438	10	IN8425MS(BZ)	3658	10
Bell Push						
6A Bell Push switch	IN8405	579	10	IN8405(BZ)	699	10
6A Bell Push switch (2M)	IN8425	936	10	IN8425(BZ)	1109	10
6A Bell Push switch with Neon	IN8485	834	10	IN8485(BZ)	983	10
6A Bell Push switch with Neon (2M)	IN8486	989	10	IN8486(BZ)	1220	10
6A Momentary Switch, WH	IN8487	774	10	IN8487_BZ	914	10
Sockets						
6A 3PIN Socket Outlet with Shutter (BIS)	IN8426UNS	667	10	IN8426UNS_BZ	807	10
6A/16A 3 Pin Socket with Shutter	IN8426/16	992	10	IN8426/16(BZ)	1215	10
Fan Regulators & Dimmers						
Fan Control (5 Speeds)	IN84SFR	2359	5	IN84SFR(BZ)	2831	5
Full Flat 500W Dimmer Module (1 Gang)	IN8404D	2143	10	IN8404D(BZ)	2539	10
USB Chargers						
1 Gang USB Charger - 2.1A (1M)	IN8431USB_WE	3826	10	IN8431USB_BZ	4389	10
2.4A 5V A+C USB Charger (1M)	IN8431ACUSB_WE	4228	10	IN8431ACUSB_BZ	4846	10
Accessories						
RJ11 Telephone Outlet with shutter (1 Gang)	IN8431RJS4	638	10	IN8431RJS4(BZ)	786	10
RJ45 Cat6 Data Outlet with shutter	IN8431RJ6	2240	10	IN8431RJ6(BZ)	2736	10
Data Outlet Wall Plate (for RJ45 key stone jack)	IN8431RJC	826	10	IN8431RJC(BZ)	971	10
TV Socket	IN8431TV	487	10	IN8431TV(BZ)	616	10
Cord Outlet	IN8445CO	615	10	-	-	-
Foot Lamp with White LED (2M)	IN8490FLW	4501	10	-	-	-
Foot Lamp with Yellow LED (2M)	IN8490FLY	4389	10	-	-	-
Blank off unit (1M)	IN8430X	149	10	IN8430X(BZ)	183	10
Hotel Series						
Do Not Disturb Panel	INH8451	3416	10	INH8451(BZ)	3825	10
Make My Room Panel	INH8454	3105	10	INH8454(BZ)	3465	10
Do Not Disturb Switch	INH8452	1696	10	INH8452(BZ)	1855	10
Do Not Disturb Switch (2M)	-	-	-	INH8453(BZ)	2041	10
Make My Room Switch	INH8455	1657	10	INH8455(BZ)	1955	10

Please contact Customer Care Center for Stockable and Non stockable status of references.

NORMAL STOCK ITEMS

W.E.F. January 17th, 2024

ZENcelo India - The Revolutionary Full-Flat Switch

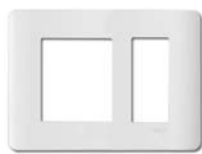

IN8403C

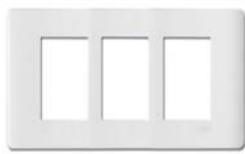

IN8406C



IN8402C(BZ)



IN8404C(SZ)

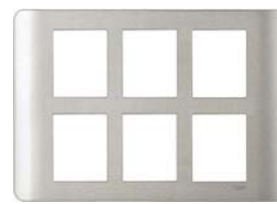

IN84012C(SA)

Description	Reference for White	Unit MRP [₹]	Pack	Reference for Dark Grey	Unit MRP [₹]	Pack	Reference for Silver Bronze	Unit MRP [₹]	Pack	Reference for Satin Silver	Unit MRP [₹]	Pack
Cover Plates												
1M Grid & 1M Cover Frame	IN8401C	383	10	IN8401C(BZ)	453	10	IN8401C(SZ)	1063	10	IN8401C(SA)	1166	10
2M Grid & 2M Cover Frame	IN8402C	397	10	IN8402C(BZ)	474	10	IN8402C(SZ)	1052	10	IN8402C(SA)	1154	10
3M Grid & 3M Cover Frame	IN8403C	468	10	IN8403C(BZ)	560	10	IN8403C(SZ)	1293	10	IN8403C(SA)	1418	10
4M Grid & 4M Cover Frame	IN8404C	510	10	IN8404C(BZ)	657	10	IN8404C(SZ)	1553	10	IN8404C(SA)	1705	10
6M Grid & 6M Cover Frame	IN8406C	778	5	IN8406C(BZ)	925	5	IN8406C(SZ)	2133	5	IN8406C(SA)	2340	5
8M Grid & 8M Cover Frame - Horizontal	IN8408HC	925	5	IN8408HC(BZ)	1106	5	IN8408HC(SZ)	2882	5	IN8408HC(SA)	3163	5
8M Grid & 8M Cover Frame - Square	IN8408SC	1234	5	IN8408SC(BZ)	1705	5	IN8408SC(SZ)	3500	5	IN8408SC(SA)	3840	5
9M Grid & 9M Cover Frame	IN8409C	1682	5	IN8409C(BZ)	2103	5	IN8409C(SZ)	4838	5	-	-	-
12M Grid & 12M Cover Frame	IN84012C	2028	5	IN84012C(BZ)	2495	5	IN84012C(SZ)	6446	5	IN84012C(SA)	7075	5
18M Grid & 18M Cover Frame	IN84018C	2860	5	IN84018C(BZ)	3693	5	IN84018C(SZ)	8533	5	IN84018C(SA)	9365	5

ZENcelo - The Revolutionary Full-Flat Switch



E8431EKT-OS



E8431BPDM>SZ-OS



E84T727H-OS



E84T727V>SZ-OS

Description	Reference for White	Unit MRP [₹]	Pack	Reference For Silver Bronze	Unit MRP [₹]	Pack
Hotel Series						
"Please Clean Up" Symbols	E8431BPDM-OS	6,727		E8431BPDM>SZ-OS	8,392	1
16A Electronic Key Card Time Delay Switch	E8431EKT-OS	13,441		E8431EKT>SZ-OS	16,803	1
Universal Shaver Unit, Vertical	E84T727V-OS	7,604		E84T727V>SZ-OS	9,472	1
Universal Shaver Unit, Horizontal	E84T727H-OS	7,604		E84T727H>SZ-OS	9,472	1

Please contact Customer Care Center for Stockable and Non stockable status of references.

NORMAL STOCK ITEMS

W.E.F. January 17th, 2024

Wiring Diagram ZENcelo

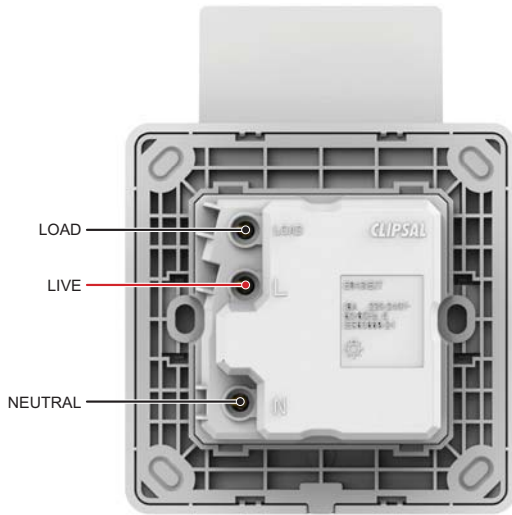

> 16A Electronic Key Card Time Delay
E8431EKT-OS, E8431EKT>SZ-OS

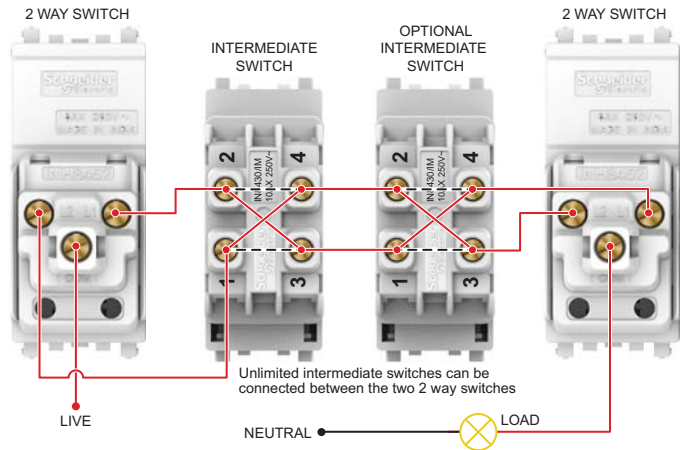

> 10AX Intermediate Switch
IN430/IM, IN430/IM (BZ)

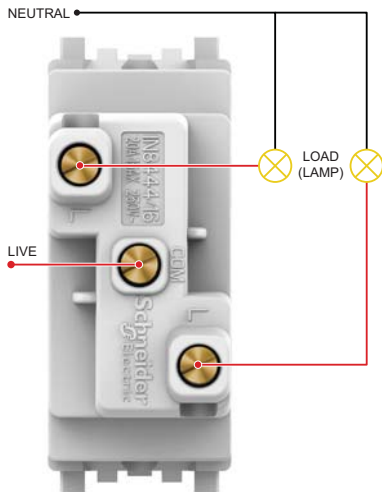

> 16AX~20A 1 Way 2G Switch (1M)
IN8444/16, IN8444/16 (BZ)

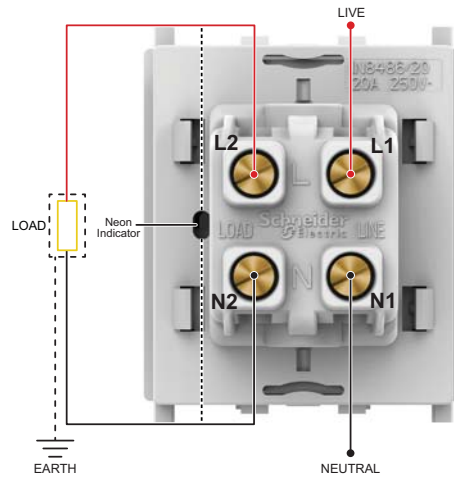

> 20A DP Switch with Neon (2M)
IN8486/20, IN8486/20 (BZ)

Please contact Customer Care Center for Stockable and Non stockable status of references.

☑ NORMAL STOCK ITEMS

W.E.F. January 17th, 2024

Wiring Diagram ZENcelo

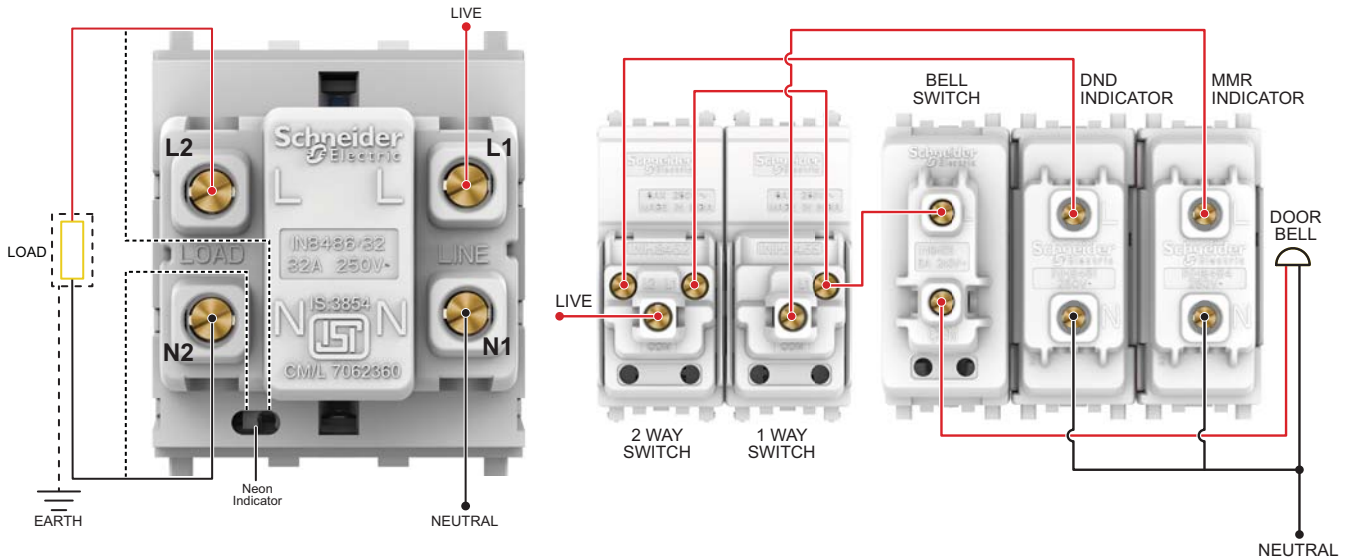

> 32A DP Switch with Neon (2M)

IN8486/32, IN8486/32 (BZ)

> Do Not Disturb Panel > Make My Room Panel > Do Not Distrub Switch > Make My Room Switch

INH8451, INH8451 (BZ), INH8454, INH8454 (BZ),
INH8452, INH8452 (BZ), INH8455, INH8455 (BZ)

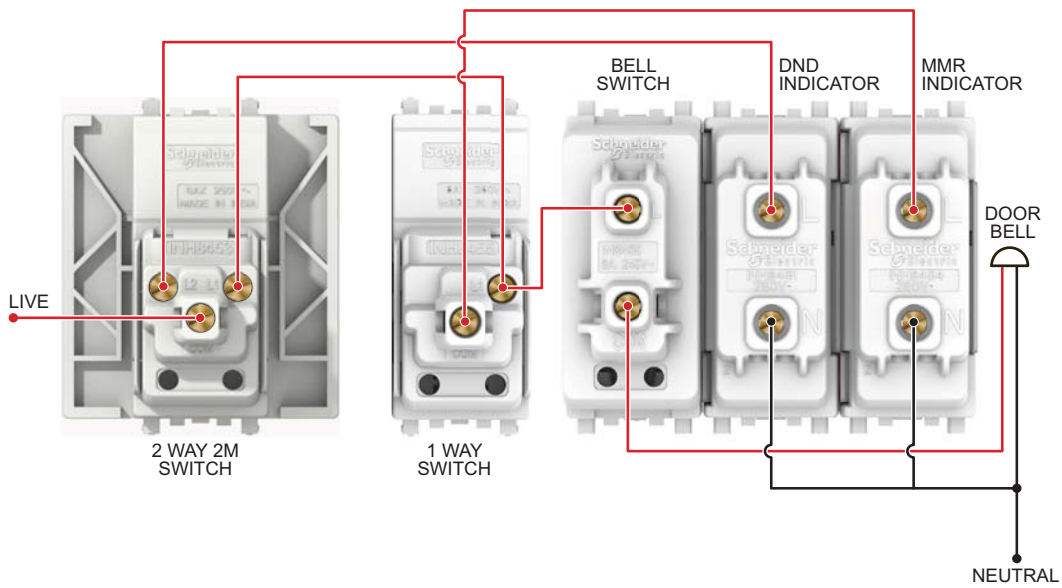

> Do Not Disturb Panel > Make My Room Panel > Do Not Disturb Switch (2M) > Make My Room Switch

INH8451, INH8451 (BZ), INH8454, INH8454 (BZ)
INH8453 (BZ), INH8455, INH8455 (BZ)

Please contact Customer Care Center for Stockable and Non stockable status of references.

NORMAL STOCK ITEMS

W.E.F. January 17th, 2024

AvatarOn - It's also a Switch



White
(WE)



Wine Gold
(WG)



Dark Grey
(DG)



Dark Wood
(WD)



Gold Hairline
(GH)



Light Wood
(LW)



Award-winning Designs: In 2017, AvatarOn gained international recognition for its innovative design and quality excellence and was awarded the iF Design Award

Ingenious Beauty

- The ground-breaking AvatarOn series is a true marriage of aesthetics and practicality, making it a perfect choice for all home or office designs.

Safe and Reliable

- Our patented "Slim Rocker, Sure Click" SS technology not only gives AvatarOn a greater thinness overall, but also a near-zero contact jitter that reduces sparks, thus ensuring a safe and reliable use.

Customisable Covers for True Adaptability

- AvatarOn switches are available in an array of replaceable covers for full customisation and integration into any home decor. The customised pattern covers of AvatarOn provides you with an extra canvas to showcase your creativity in a subtle yet apparent way.

Modern Look

- The stylish and streamlined design of AvatarOn switch covers are finished in white, soft wood, dark wood and gold hairline materials for a classic look and universal elegance.

Tech-chic Design that Shines

- The AvatarOn soft LED locators merges seamlessly with its sleek giant dolly, creating a stylish and streamlined design and glow with a soft luminescent in the dark, indicating the exact location of each switch at night.

Multifunctional Accessories for Every Day Conveniences





















Product Description	Color	Product Ref. No.	Unit MRP [₹]	Pack
16A Switches (Base + Cover Plate)				
16AX 250V 1 Gang 1 Way Switch	White	E8331L1_WE_G8	588	1
	Wine Gold	E8331L1_WG_G8	884	10
	Dark Grey	E8331L1_DG_G8	884	1
	Metal Gold Hairline	E8331L1_GH_G8	884	10
	Light Wood	E8331L1_LW_G8	917	10
	Dark Wood	E8331L1_WD_G8	884	10
16AX 250V 1 Gang 1 Way Switch with LED Indicator	White	E8331L1LED_WE_G8	884	1
	Wine Gold	E8331L1LED_WG_G8	1322	10
	Dark Grey	E8331L1LED_DG_G8	1322	1
	Metal Gold Hairline	E8331L1LED_GH_G8	1322	10
	Light Wood	E8331L1LED_LW_G8	1496	10
	Dark Wood	E8331L1LED_WD_G8	1322	10
16AX 250V 1 Gang 2 Way Switch	White	E8331L2_WE_G8	629	1
	Wine Gold	E8331L2_WG_G8	943	10
	Dark Grey	E8331L2_DG_G8	943	1
	Metal Gold Hairline	E8331L2_GH_G8	943	10
	Light Wood	E8331L2_LW_G8	979	10
	Dark Wood	E8331L2_WD_G8	943	10
16AX 250V 1 Gang 2 Way Switch with LED Indicator	White	E8331L2LED_WE_G8	943	10
	Wine Gold	E8331L2LED_WG_G8	1416	10
	Dark Grey	E8331L2LED_DG_G8	1416	1
	Metal Gold Hairline	E8331L2LED_GH_G8	1416	10
	Light Wood	E8331L2LED_LW_G8	1603	10
	Dark Wood	E8331L2LED_WD_G8	1603	10
16AX 250V 2 Gang 1 Way Switch	White	E8332L1_WE_G8	908	1
	Wine Gold	E8332L1_WG_G8	1364	10
	Dark Grey	E8332L1_DG_G8	1364	1
	Metal Gold Hairline	E8332L1_GH_G8	1364	10
	Light Wood	E8332L1_LW_G8	1364	10
	Dark Wood	E8332L1_WD_G8	1364	10
16AX 250V 2 Gang 1 Way Switch with LED Indicator	White	E8332L1LED_WE_G8	1364	1
	Wine Gold	E8332L1LED_WG_G8	2047	10
	Dark Grey	E8332L1LED_DG_G8	2047	1
	Metal Gold Hairline	E8332L1LED_GH_G8	2047	10
	Light Wood	E8332L1LED_LW_G8	2317	10
	Dark Wood	E8332L1LED_WD_G8	2047	10
16AX 250V 2 Gang 2 Way Switch	White	E8332L2_WE_G8	1106	1
	Wine Gold	E8332L2_WG_G8	1659	10
	Dark Grey	E8332L2_DG_G8	1659	1
	Metal Gold Hairline	E8332L2_GH_G8	1659	10
	Light Wood	E8332L2_LW_G8	1878	10
	Dark Wood	E8332L2_WD_G8	1659	10

Please contact Customer Care Center for Stockable and Non stockable status of references.

NORMAL STOCK ITEMS

W.E.F. January 17th, 2024

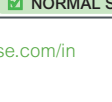
AvatarOn - It's also a Switch

		Product Description	Color	Product Ref. No.	Unit MRP [₹]	Pack
16A Switches (Base + Cover Plate)						
 E8332L2LED_WE_G8	 E8332L2LED_WD_G8	16AX 250V 2 Gang 2 Way Switch with LED Indicator	White	E8332L2LED_WE_G8	1,659	10
			Wine Gold	E8332L2LED_WG_G8	2,490	10
			Dark Grey	E8332L2LED_DG_G8	2,490	1
			Metal Gold Hairline	E8332L2LED_GH_G8	2,490	10
			Dark Wood	E8332L2LED_WD_G8	2,490	10
 E8333L1LED_WE_G8	 E8333L1LED_WD_G8	16AX 250V 3 gang 1 Way Switch	White	E8333L1_WE_G8	1,491	1
			Wine Gold	E8333L1_WG_G8	2,238	10
			Dark Grey	E8333L1_DG_G8	2,280	1
			Metal Gold Hairline	E8333L1_GH_G8	2,238	10
			Light Wood	E8333L1_LW_G8	2,238	10
 E8333L2_WE_G8	 E8333L2_WD_G8	16AX 250V 3 gang 1 Way Switch with LED Indicator	Dark Wood	E8333L1_WD_G8	2,238	10
			White	E8333L1LED_WE_G8	2,238	10
			Wine Gold	E8333L1LED_WG_G8	3,355	10
			Dark Grey	E8333L1LED_DG_G8	3,355	1
			Metal Gold Hairline	E8333L1LED_GH_G8	3,355	10
 E8333L2LED_WE_G8	 E8333L2LED_WD_G8	16AX 250V 3 gang 2 Way Switch	Light Wood	E8333L1LED_LW_G8	3,798	10
			Dark Wood	E8333L1LED_WD_G8	3,355	10
			White	E8333L2_WE_G8	1,605	1
			Wine Gold	E8333L2_WG_G8	2,409	10
			Dark Grey	E8333L2_DG_G8	2,409	1
 E8334L1_WE_G8	 E8334L1_WD_G8	16AX 250V 3 gang 2 Way Switch with LED Indicator	Metal Gold Hairline	E8333L2_GH_G8	2,409	10
			Light Wood	E8333L2_LW_G8	2,409	10
			Dark Wood	E8333L2_WD_G8	2,409	10
			White	E8333L2LED_WE_G8	2,409	10
			Wine Gold	E8333L2LED_WG_G8	3,612	10
 E8334L1LED_WE_G8	 E8334L1LED_WD_G8	16AX 250V 4 Gang 1 Way Switch	Dark Grey	E8333L2LED_DG_G8	3,612	1
			Metal Gold Hairline	E8333L2LED_GH_G8	3,612	10
			Light Wood	E8333L2LED_LW_G8	3,904	10
			Dark Wood	E8333L2LED_WD_G8	3,612	10
			White	E8334L1_WE_G8	2,145	1
 E8334L2_WE_G8	 E8334L2_WD_G8	16AX 250V 4 Gang 1 Way Switch with LED Indicator	Wine Gold	E8334L1_WG_G8	3,219	10
			Dark Grey	E8334L1_DG_G8	3,219	1
			Metal Gold Hairline	E8334L1_GH_G8	3,219	10
			Light Wood	E8334L1_LW_G8	3,219	10
			Dark Wood	E8334L1_WD_G8	3,219	10
 E8334L2LED_WE_G8	 E8334L2LED_WD_G8	16AX 250V 4 Gang 2 Way Switch	White	E8334L1LED_WE_G8	3,219	10
			Wine Gold	E8334L1LED_WG_G8	4,827	10
			Dark Grey	E8334L1LED_DG_G8	4,827	1
			Metal Gold Hairline	E8334L1LED_GH_G8	4,827	10
			Light Wood	E8334L1LED_LW_G8	5,465	10
 E8334L2LED_WE_G8	 E8334L2LED_WD_G8	16AX 250V 4 Gang 2 Way Switch with LED Indicator	Dark Wood	E8334L1LED_WD_G8	4,827	10
			White	E8334L2_WE_G8	2,468	1
			Wine Gold	E8334L2_WG_G8	3,700	10
			Dark Grey	E8334L2_DG_G8	3,770	1
			Metal Gold Hairline	E8334L2_GH_G8	3,700	10
 E8334L2LED_WE_G8	 E8334L2LED_WD_G8	16AX 250V 4 Gang 2 Way Switch with LED Indicator	Light Wood	E8334L2_LW_G8	3,700	10
			Dark Wood	E8334L2_WD_G8	3,700	10
			White	E8334L2LED_WE_G8	3,700	10
			Wine Gold	E8334L2LED_WG_G8	5,551	10
			Dark Grey	E8334L2LED_DG_G8	5,551	1
			Metal Gold Hairline	E8334L2LED_GH_G8	5,551	10
			Dark Wood	E8334L2LED_WD_G8	5,551	10

Please contact Customer Care Center for Stockable and Non stockable status of references.

NORMAL STOCK ITEMS

W.E.F. January 17th, 2024

AvatarOn - It's also a Switch



E8331M_WE_G8



E8331PRL1_WD_G8



E8332PRL1_WE_G8



E8332PRL1_WD_G8



E8331D20N_WE_G8



E8331D20N_WD_G8



E8331D32N_WE_G8



E8332D20N_WD_G8



E8332D20N_WE_G8



E8331D32N_WD_G8



E8331D45N_WE_G8



E8331D45N_WD_G8

Product Description	Color	Product Ref. No.	Unit MRP ₹	Pack
16A Intermediate Switches				
16AX 250V 1 Gang Intermediate Switch	White	E8331M_WE_G8	1,976	1
	Wine Gold	E8331M_WG_G8	2,964	1
	Dark Grey	E8331M_DG_G8	2,964	1
10A Momentary Switches				
10A 250V 1 Gang Momentary Switch	Dark Wood	E8331PRL1_WD_G8	1037	10
	White	E8332PRL1_WE_G8	870	10
10A 250V 2 Gang Momentary Switch	Wine Gold	E8332PRL1_WG_G8	1303	10
	Dark Grey	E8332PRL1_DG_G8	1303	1
	Metal Gold Hairline	E8332PRL1_GH_G8	1,303	10
	Dark Wood	E8332PRL1_WD_G8	1,303	10
Double Pole Switches				
20A 250V 1 Gang Double Pole Switch with LED Indicator	White	E8331D20N_WE_G8	1,535	10
	Wine Gold	E8331D20N_WG_G8	2,299	10
	Dark Grey	E8331D20N_DG_G8	2,299	1
	Metal Gold Hairline	E8331D20N_GH_G8	2,299	10
	Light Wood	E8331D20N_LW_G8	2,237	10
	Dark Wood	E8331D20N_WD_G8	2,299	10
20A 250V 2 Gang Double Pole Switch with LED Indicator	White	E8332D20N_WE_G8	1,954	10
	Wine Gold	E8332D20N_WG_G8	2,760	10
	Dark Grey	E8332D20N_DG_G8	2,760	1
	Metal Gold Hairline	E8332D20N_GH_G8	2,760	10
	Dark Wood	E8332D20N_WD_G8	2,760	10
32A 250V 1 Gang Double Pole Switch with LED Indicator	White	E8331D32N_WE_G8	2,036	10
	Wine Gold	E8331D32N_WG_G8	3,053	10
	Dark Grey	E8331D32N_DG_G8	3,053	1
	Metal Gold Hairline	E8331D32N_GH_G8	3,053	10
	Light Wood	E8331D32N_LW_G8	3,053	10
45A 250V 1 Gang Double Pole Switch with LED Indicator	Dark Wood	E8331D32N_WD_G8	3,053	10
	White	E8331D45N_WE_G8	2,543	10
	Wine Gold	E8331D45N_WG_G8	3,817	10
	Dark Grey	E8331D45N_DG_G8	3,887	1
	Metal Gold Hairline	E8331D45N_GH_G8	3,887	10
	Dark Wood	E8331D45N_WD_G8	3,643	10

Please contact Customer Care Center for Stockable and Non stockable status of references.

NORMAL STOCK ITEMS

W.E.F. January 17th, 2024

AvatarOn - It's also a Switch



E8331BPL1_WE_G8



E8331BPL1_WD_G8



E8315_16_WE



E8315_16_WD



E8331FR350_WE_G8



E8331FR350_WD_G8



E8331_WE



E8331_WD



E8331KH_WE



E8332_WE



E8332_WD



E8333_WE

Product Description	Color	Product Ref. No.	Unit MRP ₹	Pack	
Bell Push Switch					
10A 250V Door Bell Push Switch	White	E8331BPL1_WE_G8	653	1	
	Wine Gold	E8331BPL1_WG_G8	977	10	
	Dark Grey	E8331BPL1_DG_G8	977	1	
	Metal Gold Hairline	E8331BPL1_GH_G8	977	10	
	Light Wood	E8331BPL1_LW_G8	977	10	
	Dark Wood	E8331BPL1_WD_G8	977	10	
Sockets					
6A 2/3 Pin Switched Socket	White	E8315_6_WE	1,293	8	
	Wine Gold	E8315_6_WG	1,675	8	
	Dark Grey	E8315_6_DG	1,644	1	
	Metal Gold Hairline	E8315_6_GH	1,644	8	
	Light Wood	E8315_6_LW	1,675	8	
	Dark Wood	E8315_6_WD	1,644	8	
6/16A Switched Socket	White	E8315_16_WE	1,623	8	
	Wine Gold	E8315_16_WG	2,064	8	
	Dark Grey	E8315_16_DG	2,064	1	
	Metal Gold Hairline	E8315_16_GH	2,103	8	
	Light Wood	E8315_16_LW	2,103	8	
	Dark Wood	E8315_16_WD	2,064	8	
Fan Regulators					
5 Steps 360 Deg Fan Regulator	White	E8331FR350_WE_G8	3,081	1	
	Wine Gold	E8331FR350_WG_G8	4,061	1	
	Dark Grey	E8331FR350_DG_G8	4,061	1	
	Metal Gold Hairline	E8331FR350_GH_G8	4,061	1	
	Light Wood	E8331FR350_LW_G8	4,137	1	
	Dark Wood	E8331FR350_WD_G8	4,061	1	
Switch & Socket Covers (Additional)					
1 Gang Switch Cover	White	E8331_WE	173	1	
	Wine Gold	E8331_WG	479	1	
	Dark Grey	E8331_DG	457	1	
	Metal Gold Hairline	E8331_GH	479	1	
	Dark Wood	E8331_WD	479	1	
1 Gang Switch Cover with Keyholder	White	E8331KH_WE	380	1	
	2 Gang Switch Cover	White	E8332_WE	261	1
		Wine Gold	E8332_WG	654	1
		Dark Grey	E8332_DG	562	1
		Metal Gold Hairline	E8332_GH	654	1
		Light Wood	E8332_LW	624	1
Dark Wood	E8332_WD	654	1		
3 Gang Switch Cover	White	E8333_WE	404	1	
	Wine Gold	E8333_WG	961	1	
	Dark Grey	E8333_DG	825	1	
	Metal Gold Hairline	E8333_GH	961	1	
	Light Wood	E8333_LW	917	1	

Please contact Customer Care Center for Stockable and Non stockable status of references.

NORMAL STOCK ITEMS

W.E.F. January 17th, 2024

AvatarOn - It's also a Switch



E8334_WE



E8334_WD



E8315C_6_WE



E8315C_6_WD



E8315C_16_WE



E8315C_16_WD



E8332USB_WE_G8



E8332USB_WD_G8



E8331_26_WE



E8332ACQUSB_WE



E8331_36_WE



E8331_46_WE



E8330TX_WE

Product Description	Color	Product Ref. No.	Unit MRP ₹	Pack
4G Switch Cover	White	E8334_WE	632	1
	Wine Gold	E8334_WG	1179	1
	Dark Grey	E8334_DG	1126	1
	Metal Gold Hairline	E8334_GH	1310	1
	Light Wood	E8334_LW	1252	1
	Dark Wood	E8334_WD	1179	1
6A 2/3 Pin Switched Socket Cover	White	E8315C_6_WE	463	12
	Wine Gold	E8315C_6_WG	786	12
	Dark Grey	E8315C_6_DG	786	1
	Metal Gold Hairline	E8315C_6_GH	786	12
	Light Wood	E8315C_6_LW	874	12
	Dark Wood	E8315C_6_WD	786	12
6/16A Switched Socket Cover	White	E8315C_16_WE	500	12
	Wine Gold	E8315C_16_WG	821	12
	Dark Grey	E8315C_16_DG	821	1
	Metal Gold Hairline	E8315C_16_GH	912	12
	Light Wood	E8315C_16_LW	871	12
	Dark Wood	E8315C_16_WD	912	12
USB Chargers				
2 x 2.1A USB Charger with Mobile Holder (2.1A with 2 outputs used simultaneously)	White	E8332USB_WE_G8	7,726	1
	Wine Gold	E8332USB_WG_G8	11,589	1
	Dark Grey	E8332USB_DG_G8	11,589	1
	Metal Gold Hairline	E8332USB_GH_G8	11,589	1
	Light Wood	E8332USB_LW_G8	12,877	1
	Dark Wood	E8332USB_WD_G8	11,589	1
21W Type A+C, PD+QC3.0 USB Charger	Metal Gold Hairline	E8332ACQUSB_GH	7,065	-
	Light Wood	E8332ACQUSB_LW	7,065	-
	Dark Wood	E8332ACQUSB_WD	7,065	-
	White	E8332ACQUSB_WE	5,711	-
	Wine Gold	E8332ACQUSB_WG	7,065	-
Blasket/Frame (to ensure alignment of switches on 2/3/4 Gang metal box)				
2 Gang Blasket/Frame	White	E8331_26_WE	286	1
	Wine Gold	E8331_26_WG	375	1
	Dark Grey	E8331_26_DG	357	1
3 Gang Blasket/Frame	White	E8331_36_WE	315	1
	Wine Gold	E8331_36_WG	441	1
	Dark Grey	E8331_36_DG	421	1
4 Gang Blasket/ Frame	White	E8331_46_WE	336	1
	Wine Gold	E8331_46_WG	473	1
	Dark Grey	E8331_46_DG	451	1
Blank Plates				
1 Gang Blank Plate	White	E8330X_WE	395	1
	Wine Gold	E8330X_WG	594	1
	Dark Grey	E8330X_DG	594	1
	Metal Gold Hairline	E8330X_GH	622	1
	Dark Wood	E8330X_WD	622	1
2 Gang Blank Plate	White	E8330TX_WE	552	10
	Wine Gold	E8330TX_WG	858	10
	Dark Grey	E8330TX_DG	858	1
	Metal Gold Hairline	E8330TX_GH	858	10
	Dark Wood	E8330TX_WD	953	10

Please contact Customer Care Center for Stockable and Non stockable status of references.

NORMAL STOCK ITEMS

W.E.F. January 17th, 2024

AvatarOn - It's also a Switch



E8331BPDMW_ WE_G8



E8331BPDMW_ WD_G8



E8331KPB_WE



E8332C_WE_G8



E8332C_WD_G8



E83T727V_WE



E83T727V_WD



E8330FSG_WD



E8331RJS4_WE



E8331RJS4_WD

Product Description	Color	Product Ref. No.	Unit MRP ₹	Pack
Hotel Series				
DND, PCU, PW Indicator with Bell Switch (Do Not Disturb, Please Clean Up, Please Wait)	White	E8331BPDMW_WE_G8	5626	1
	Wine Gold	E8331BPDMW_WG_G8	8438	10
	Dark Grey	E8331BPDMW_DG_G8	8438	1
	Dark Wood	E8331BPDMW_WD_G8	8438	10
16AX 3 Gang Switch with PCU, DND, PW Sym (Do Not Disturb, Please Clean Up, Please Wait)	White	E8333DMWS_WE_G8	5354	1
	Wine Gold	E8333DMWS_WG_G8	7812	10
	Dark Grey	E8333DMWS_DG_G8	8184	1
	Dark Wood	E8333DMWS_WD_G8	8336	10
250V 16A Electronic Keycard Switch	White	E8331EKT_WE	9828	1
	Wine Gold	E8331EKT_WG	14743	1
	Dark Grey	E8331EKT_DG	14742	1
	Metal Gold Hairline	E8331EKT_GH	14742	8
	Dark Wood	E8331EKT_WD	15444	1
Panic Button with Key Reset	White	E8331KPB_WE	1699	1
	Wine Gold	E8331KPB_WG	2496	1
	Dark Grey	E8331KPB_DG	2145	1
10A 2 Gang Mechanical Curtain Switch	White	E8332C_WE_G8	1166	1
	Wine Gold	E8332C_WG_G8	1749	10
	Dark Grey	E8332C_DG_G8	1749	1
	Metal Gold Hairline	E8332C_GH_G8	1749	10
	Light Wood	E8332C_LW_G8	1855	10
	Dark Wood	E8332C_WD_G8	1749	10
115/240V 20VA Universal Version Shaver	White	E83T727V_WE	5454	1
	Wine Gold	E83T727V_WG	8835	1
	Dark Grey	E83T727V_DG	9257	1
	Metal Gold Hairline	E83T727V_GH	9257	1
Dark Wood	E83T727V_WD	9697	1	
Connection Units				
13A 250V 1 Gang Fused Connection Unit	Dark Wood	E8330FSG_WD	1647	10
13A 250V 1 Gang Fused Connection with DP Switch and Neon	Wine Gold	E8331DFSGN_WG	4797	10
	Dark Wood	E8331DFSGN_WD	4886	10
25A 250V 1 Gang Connection Unit	Metal Gold Hairline	E8331TB_GH	2131	10
Telecom, Network, Connectivity & Media Series				
1 Gang Telephone Socket, Shuttered Wallplate	White	E8331RJS4_WE	858	1
	Wine Gold	E8331RJS4_WG	1430	1
	Dark Grey	E8331RJS4_DG	1430	1
	Metal Gold Hairline	E8331RJS4_GH	1430	1
	Light Wood	E8331RJS4_LW	1589	10
	Dark Wood	E8331RJS4_WD	1430	1

Please contact Customer Care Center for Stockable and Non stockable status of references.

NORMAL STOCK ITEMS

W.E.F. January 17th, 2024

AvatarOn - It's also a Switch



E8332RJS4_WE



E8331RJS5_WE



E8332RJS5_WE



E8331RJS6_WE



E8332RJS6_WE



E8331TV_WE



E8331TVSF_WE



E8332TDRJS5_WE



E8332TVRJS5_WE



E8332HDUSB_WE



E8332HDRJS5_WE



E8332HDHD_WE



E8331VC_WE



E8331RJS_WE



E8332RJS_WE

Product Description	Color	Product Ref. No.	Unit MRP ₹	Pack
2G Tel Socket, Shuttered Wallplate	White	E8332RJS4_WE	2,105	1
	Wine Gold	E8332RJS4_WG	3,160	1
	Dark Grey	E8332RJS4_DG	3,016	1
1 Gang RJ45 Data Cat5E, Shuttered	White	E8331RJS5_WE	1,341	1
	Wine Gold	E8331RJS5_WG	2,339	1
	Dark Grey	E8331RJS5_DG	2,232	1
	Metal Gold Hairline	E8331RJS5_GH	2,232	1
	Light Wood	E8331RJS5_LW	2,480	1
	Dark Wood	E8331RJS5_WD	2,339	1
2 Gang RJ45 Data Cat5E, Shuttered	White	E8332RJS5_WE	2,451	1
	Wine Gold	E8332RJS5_WG	4,088	1
	Dark Grey	E8332RJS5_DG	3,902	1
	Metal Gold Hairline	E8332RJS5_GH	3,902	10
	Dark Wood	E8332RJS5_WD	4,088	1
	White	E8331RJS6_WE	1,602	1
1 Gang RJ45 Data Cat6, Shuttered	Wine Gold	E8331RJS6_WG	2,402	1
	Dark Grey	E8331RJS6_DG	2,402	1
	White	E8332RJS6_WE	3,002	1
2 Gang RJ45 Data Cat6, Shuttered	Wine Gold	E8332RJS6_WG	4,504	1
	Dark Grey	E8332RJS6_DG	4,504	1
	White	E8331TV_WE	676	1
	Wine Gold	E8331TV_WG	1,126	1
	Dark Grey	E8331TV_DG	1,126	1
	Metal Gold Hairline	E8331TV_GH	1,126	10
1 Gang TV Socket, 75Ω, Through-Connect	Light Wood	E8331TV_LD	1,193	10
	Dark Wood	E8331TV_WD	1,126	1
	White	E8331TVSF_WE	747	10
	Wine Gold	E8331TVSF_WG	1,252	0
	Dark Grey	E8331TVSF_DG	1,193	1
	White	E8332TDRJS5_WE	2,105	1
1 Gang Tel + RJ45 Data Cat5E, Shuttered	Wine Gold	E8332TDRJS5_WG	3,509	1
	Dark Grey	E8332TDRJS5_DG	3,350	1
	Metal Gold Hairline	E8332TDRJS5_GH	3,350	1
	Dark Wood	E8332TDRJS5_WD	3,509	1
	White	E8332TVRJS5_WE	2,610	1
	Wine Gold	E8332TVRJS5_WG	4,356	1
1 Gang TV+ RJ45 Data Cat5E, Shuttered	Dark Grey	E8332TVRJS5_DG	4,157	1
	Metal Gold Hairline	E8332TVRJS5_GH	4,157	1
	Dark Wood	E8332TVRJS5_WD	4,840	1
	White	E8332TVRJS6_WE	2,610	1
	Wine Gold	E8332TVRJS6_WG	4,356	1
	Dark Grey	E8332TVRJS6_DG	4,157	1
HDMI + USB Socket	White	E8332HDUSB_WE	5,563	1
	Wine Gold	E8332HDUSB_WG	9,271	8
	Dark Grey	E8332HDUSB_DG	8,848	1
HDMI + RJ45 Data Cat5E, Shuttered	White	E8332HDRJS5_WE	3,762	1
	Wine Gold	E8332HDRJS5_WG	5,641	1
	Dark Grey	E8332HDRJS5_DG	5,077	1
2 Gang HDMI+HDMI, Keystone on Wallplate	White	E8332HDHD_WE	3,051	1
	Wine Gold	E8332HDHD_WG	5,085	8
	Dark Grey	E8332HDHD_DG	5,085	1
Volume Control, 5W, 8Ohm	White	E8331VC_WE	2,428	1
	Wine Gold	E8331VC_WG	3,642	10
	Dark Grey	E8331VC_DG	3,642	1
1 Gang S Keystone Wallplate (w/o Mod)	White	E8331RJS_WE	634	10
	Wine Gold	E8331RJS_WG	951	10
	Dark Grey	E8331RJS_DG	951	1
2 Gang S Keystone Wallplate (w/o Mod)	White	E8332RJS_WE	1,191	10
	Wine Gold	E8332RJS_WG	1,786	10
	Dark Grey	E8332RJS_DG	1,786	1

Please contact Customer Care Center for Stockable and Non stockable status of references.

NORMAL STOCK ITEMS

W.E.F. January 17th, 2024

Kavacha - Weather Protected Series



CSW110-GY-EX



A3031WBP_WE

- Pleasing looks with **IP56 protection**
- Large press switch
- Co-moulded sealing with no risk of gasket damage
- Chemical resistant & UV stabilised

Description	Reference	Unit MRP ₹	Pack
Kavacha IP56 Surface Mount Switches			
Switches with Looping Terminal			
10A 1 Gang 2 Way Switch	CSW110-GY-EX	3,897	1
10A 1 Gang 2 Way Bell Press Return Switch	CSW110BPR-GY-EX	4,319	1
Double Pole Switches			
20A 1 Gang Double Pole Switch	CSW220-GY-EX	5855	1
Kavacha Heavy Duty Isolator Switches			
35A Triple Pole	WHT35-GY-EX	8,390	1
63A Triple Pole	WHT63-GY-EX	10,806	1
Kavacha IP56 Surface Mount Combined Switched Socket Outlets			
Combination Switch Socket Outlets			
16A Single Pole Switched Socket Outlet	CSC316RP_GY	4796	1
Kavacha IP56 Surface Mount Socket Outlets			
16A Socket Outlet	CSO316RP-GY-EX	3080	1
Kavacha Full-Time Weatherproof Cover			
Full-Time Weatherproof Single Gang Socket Cover (Transparent) IP55	E223R_TR	1115	1
Weatherproof Bell Press Grey	A3031WBP_GY	1687	1
Weatherproof Bell Press White	A3031WBP_WE	1474	1

Please contact Customer Care Center for Stockable and Non stockable status of references.

NORMAL STOCK ITEMS

W.E.F. January 17th, 2024

Metal Boxes



- **Weld free design** to minimize corrosion and rusting without compromising on strength
- Mounting clip and earth pin designed for **easier installation** and to **avoid loss during transportation**
- Removable side plates and optimized knock outs and for **easier wiring**
- Completely tested & validated as per **IS 14772**

Description	Reference	Unit MRP ₹	Pack
Metal Boxes for Indian Format Ranges (Livia, Opale Clipsal X, Unica Pure & ZENcelo India) NEW			
0.8 mm thickness			
Metal Box 1 & 2 modules	ME0102	108	20
Metal Box 3 modules	ME0103	139	20
Metal Box 4 modules	ME0104	161	20
1 mm thickness			
Metal Box 1 & 2 modules	MR1102	119	20
Metal Box 3 modules	MR1103	158	20
Metal Box 4 modules	MR1104	182	20
Metal Box 6 modules	MR1106	247	10
Metal Box 8 modules - Horizontal	MR1108	320	10
Metal Box 8 modules - Square	MR1109	320	10
Metal Box 12 module	MR1112	412	5
Metal Box 18 modules	MR1118	488	5

Description	Reference	Unit MRP ₹	Pack
Metal Boxes for BS Format Ranges (AvatarON,ZENcelo BS, NEO, ULTI) - New & Improved Design NEW			
Use Bracket/Frame to ensure alignment of switches on 2/3/4 Gang Metal Box (refer to Avataron section for references)			
1 mm thickness			
2 GANG GI Metal Boxes	MM1102	300	20
3 GANG GI Metal Boxes	MM1103	425	20
4 GANG GI Metal Boxes	MM1104	550	20

- Special Metal Box with Gang Partition to accommodate BS format ranges
- Single Metal Box can accommodate up to 4 units
- Number of Gangs for Metal Box = Number of units that it can accommodate (Eg. 3 GANG Metal Box can accommodate up to 3 BS format Units)

Please contact Customer Care Center for Stockable and Non stockable status of references.

✔ NORMAL STOCK ITEMS

W.E.F. January 17th, 2024

MAKE YOUR HOME SMART WITH OUR WISER - SMART HOMES OFFERING

EASY OPERATION | EASY MAINTENANCE | EASY CONTROL | POCKET FRIENDLY

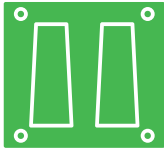

Retrofittable Solution Without any Change in Wiring Infrastructure of the Switches



IoT Technology for & Secure Aspirational Lifestyle Through Automation



Personalized at-Home Experience with the Luxury to Schedule your Appliances for Convenience

Once there were smart homes, now there are Wiser

Wiser smart home technology revolve around human emotions adding new dimensions to being stylish, aspirational & eco-friendly. Wiser interlinks electrical, multimedia, and telecommunication systems of the house into a single world empowering you to track, control and access your home anytime from anywhere.



Seamless Wifi Interlinking to all Devices of any Brand & Make



Voice- Enabled & Intuitive App Interface for an Hassle Free User Experience



Control & Access Your Home From Anywhere Through Secured Connection



Manage your Energy Consumption to Save on your Bills & Contribute to Sustainability

SE Ref.	Description of reference	Unit MRP [₹]
Wiser 4 Channel Automation Relay	IH14000100	20,000
Wiser Automation Gateway	IH101ZWIFI	38,980
2 Channel Dimmer Controller	IH12000020	20,000
Wiser 1 Channel Analog Dimmer + 1 Channel Direct dimmer Controller	IH12001010	20,000
Wiser Curtain Controller	IH11000200	20,000
Fan Speed Controller	IH1200010F	20,000
Smart Doorbell	IH100WFVDP	35,000
IR Controller	IH101ZW2IR	20,000

Please contact Customer Care Center for Stockable and Non stockable status of references.

NORMAL STOCK ITEMS

W.E.F. January 17th, 2024

Surface and Flush Mount Occupancy Sensors



PIR, Ultrasonic Sensors & High Frequency sensor suitable for both Surface & Flush Mount

Description	Reference	Unit MRP [₹]
Surface Mount Single-Load 360 degrees PIR	CSS54E_WE	3,864
Flush/Surface Mount Single-Load 360 degrees PIR	SAE-UE-MS-CSAWE	4,660
ARGUS Presence Dual-Tech PIR & Ultrasonic Sensor - 1ch	CCT551011	18,575
ARGUS Presence Dual-Tech - 2ch	CCT551012	16,469
ARGUS IR Remote Controller Dual-Tech	CCT556011	18,320
ARGUS Presence High Frequency High Bay Sensor - 2ch	CCT551023	18,023
ARGUS IR Remote Controller HF	CCT556023	16,794
ARGUS Presence Wide Sense - 2ch	CCT551003	15,260
INFRASCAN OUTDOOR 3WIRE 10A	750WPR-GY	19,647
INFRASCAN INDOOR 3WIRE 10A	751R-WE	12,727
INFRASCAN 360DEGREE 3WIRE	753R-WE	11,901



PIR Flush Mount Sensors

Description	Reference	Unit MRP [₹]
ARGUS Standard min 360° False ceiling indoor movement detector	CCT570005	5,453
ARGUS Standard 360° False ceiling indoor movement detector - 2ch	CCT570003	8,007
Flush Mount Dual load 360 degrees standalone sensor	SAE-UE-MS-CDBWE	9,298



Dimmable Sensors with Light Regulation

0-10V Analogue & Dali Dimmable Sensor

Description	Reference	Unit MRP [₹]
Flush/Surface Mount Dual Load 360° PIR, 0-10V Analogue Dimmable Sensor with remote	SAE-UE-MS-CDDWE	13,298
ARGUS Presence DALI 230V - 2 zones	CCT552006	19,237
ARGUS Presence DALI 230V - Slave	CCT555006	15,477
ARGUS IR Remote Controller DALI	CCT556006	19,238
ARGUS Presence Master with IR, DALI	MTN5510-1519	21,075

Please contact Customer Care Center for Stockable and Non stockable status of references.

NORMAL STOCK ITEMS

W.E.F. January 17th, 2024

Wall Mount Sensors



BS Standard & Outdoor IP55 Sensor

Description	Reference	Unit MRP [₹]
Neo C-Metro 200 degrees wall mount sensor, grey colour	E3751MS3C_GS	7,255
Zencelo 110 degrees wall mount sensor, white colour	E84751MS3B_WE	6,058
Zencelo 90 degrees wall mount sensor, white colour	E84751MS3A_WE	6,058
Argus 110 Electronic outdoor movement detector, angle of detection 110 degrees, max. range 12 mtrs, IP55 protection	MTN565119	8,029
Argus 220 Electronic movement detector for outdoor ceiling mounting angle of detection 220 degrees, max. range 12 mtrs, IP55 protection	MTN565219	12,388

Hotel - ELV Dual Motion Sensor

Description	Reference	Unit MRP [₹]
ELV DUAL TECH MOTION SENSOR	SAE_UE_MS_CULV_WE	13,114

Please contact Customer Care Center for Stockable and Non stockable status of references.

NORMAL STOCK ITEMS

W.E.F. January 17th, 2024

Life Is 

Schneider
 Electric

Schneider Electric India Pvt. Ltd.

Corporate Office: 9th Floor, DLF Building No. 10, Tower C, DLF Cyber City, Phase II, Gurugram 122002 Haryana
Tel.: ++91 124 6899000 Fax: ++91 124 4222036/037

Ahmedabad

Schneider Electric India (P) Ltd.
1506-1507, 15th Floor Shapth-5
Opp.Karnavati Club, SG Highway,
Ahmedabad, Gujarat - 380015
Tel.: 079-66826701

Bengaluru

Schneider Electric India (P) Ltd.
No. 3/1, JP Techno Park
Mezzanine Floor, Millers Tank Bund
Road, Vasanth Nagar
Bengaluru - 560052
Tel.: 080-71481351

Bhubaneswar

Schneider Electric India (P) Ltd.
Workloop Co-Working in the property
Office No. 316, Esplanade One Mall
Rasulgarh, Bhubaneswar - 751010

Chennai

Schneider Electric India (P) Ltd.
No: 29, 2nd Floor,
Bannari Amman Towers, B-Block
Dr. Radhakrishnan Road, Mylapore
Chennai - 600 004
Tel.:044-71912000

Cochin

Schneider Electric India (P) Ltd.
Alapatt Properties Private Limited
(Trade Name : Centre A)
Main Door Number : 66/4971
(Old Door Number: 40/6584-H)
7th Floor Alapatt Heritage Building
MG Road Kochi - 682035

Coimbatore

Schneider Electric India (P) Ltd.
Hanudev Info Tech Park, 6th Floor
Unit No. Block-C, SF No. 558/2
Udalyampalayam Road, Nava India
Coimbatore - 641028

Hyderabad

Schneider Electric India (P) Ltd.
D.No. 1-8-271, # 401, Ashoka
Bhoopal Chambers, SP Road
Secunderabad - 500003
Tel.: 040-67219500

Indore

Schneider Electric India (P) Ltd.
219, Dhan Trident Building
Vijay Nagar, A.B.Road
Indore - 452001

Jaipur

Schneider Electric India (P) Ltd.
Jaipur Business Centre 309
3rd Floor, Sangam Tower 190
Church Road, Jaipur - 302001
Tel.: 0141-2374810

Kolkata

Schneider Electric (I) Pvt.Ltd,
BP-4, Sector-V, Technopolis
3rd Floor, Salt Lake City
Kolkata - 700 091
Tel.: 033-66576400

Lucknow

Schneider Electric India (P) Ltd.
Summit, Plot No. TCG 3/3
6th Floor, 604A/B/C, Vibhuti Khand
Gomti Nagar, Lucknow
Uttar Pradesh - 226010
Tel.: 0522-3500334

Ludhiana

Schneider Electric India (P) Ltd.
SCO 23, 2nd Floor,
Chandigarh Road, Sector 32
Ludhiana, Punjab -141010
Tel.: 0161- 5203011

Mohali

Schneider Electric India (P) Ltd.
2nd Floor, Tower-A
Bestech Business Tower
Mega Information & Technology Park
Industrial Plot No.1, Phase IX
(Expansion), Mohali - 160059
Tel.: 0172-7198200

Mumbai

Schneider Electric India (P)(Ltd)
Marwah House, 2nd Floor
Krishanlal Marwah Marg
Andheri (East), Mumbai - 400072
Tel.: 022-62280000

Nagpur

Schneider Electric India (P) Ltd.
6, Vasant Vihar Complex
W.H.C Road, Shankar Nagar
Nagpur - 440010
Tel.: 0712-2558581

Nashik

Schneider Electric India (P) Ltd.
401, 4th Floor, Rishi Raj Towers
Jehan Circle, Gangapur Road
Nashik - 422013
Tel.: 0253-2344333

New Delhi

Schneider Electric India (P) Ltd.
C-56, Mayapuri Industrial Area, Phase-2
New Delhi - 110064
Tel.: 011-61317400

Pune

Schneider Electric India (P) Ltd.
Amar Caliber, CTS No 911, BMCC Road,
OFF FC. Road, Deccan Gymkhana,
Shivaji Nagar, Pune - 411007
Tel.: 020-67492500

Vadodara

Schneider Electric India (P) Ltd.
Notus IT Park, 10th Floor, Block-D
Sarabhai Campus, Vadiwadi
Vadodara, Gujarat - 390017

Vishakhapatnam

Schneider Electric India (P) Ltd.
D.N.10-1-43, 1st Floor
Ratnam's Business Centre,
Siripuram Fort, C.B.M.Compound
Visakhapatnam - 530016
Tel.: 0891-6675500

Customer Care Centre

Monday-Saturday, 9 a.m. to 8 p.m.

Toll-free numbers: 1800 419 4272, 1800 103 0011

Email: customercare.in@schneider-electric.com

For more information, visit our website at: www.se.com/in

- All Prices are in Indian Rupees.
- Prices are subject to change without prior notice.
- Product evolution is a continuous process and Schneider Electric reserves the right to modify/withdraw any product at any time without prior notice.
- Prices charged will be as prevailing on the date of dispatch.
- Invoice Amount = (MRP – less Applicable discount) + Applicable GST %
- Tax incidence on invoices is basis applicable GST rates.
- Invoice amount not to exceed MRP.
- Product pictures shown are for illustration purpose only, actual product may vary.

Distributor